



AVEVA™ Enterprise Licensing Guide

© 2015-2023 AVEVA Group Limited or its subsidiaries. All rights reserved.

No part of this publication may be reproduced, stored in a retrieval system, or transmitted, in any form or by any means, mechanical, photocopying, recording, or otherwise, without the prior written permission of AVEVA Group Limited. No liability is assumed with respect to the use of the information contained herein.

Although precaution has been taken in the preparation of this documentation, AVEVA assumes no responsibility for errors or omissions. The information in this documentation is subject to change without notice and does not represent a commitment on the part of AVEVA. The software described in this documentation is furnished under a license agreement. This software may be used or copied only in accordance with the terms of such license agreement. AVEVA, the AVEVA logo and logotype, OSIsoft, the OSIsoft logo and logotype, Archedra, Avantis, Citect, DYNsIM, eDNA, EYESIM, InBatch, InduSoft, InStep, IntelaTrac, InTouch, Managed PI, OASyS, OSIsoft Advanced Services, OSIsoft Cloud Services, OSIsoft Connected Services, OSIsoft EDS, PIPEPHASE, PI ACE, PI Advanced Computing Engine, PI AF SDK, PI API, PI Asset Framework, PI Audit Viewer, PI Builder, PI Cloud Connect, PI Connectors, PI Data Archive, PI DataLink, PI DataLink Server, PI Developers Club, PI Integrator for Business Analytics, PI Interfaces, PI JDBC Driver, PI Manual Logger, PI Notifications, PI ODBC Driver, PI OLEDB Enterprise, PI OLEDB Provider, PI OPC DA Server, PI OPC HDA Server, PI ProcessBook, PI SDK, PI Server, PI Square, PI System, PI System Access, PI Vision, PI Visualization Suite, PI Web API, PI WebParts, PI Web Services, PRISM, PRO/II, PROVISION, ROMEo, RLINK, RtReports, SIM4ME, SimCentral, SimSci, Skelta, SmartGlance, Spiral Software, WindowMaker, WindowViewer, and Wonderware are trademarks of AVEVA and/or its subsidiaries. All other brands may be trademarks of their respective owners.

U.S. GOVERNMENT RIGHTS

Use, duplication or disclosure by the U.S. Government is subject to restrictions set forth in the license agreement with AVEVA Group Limited or its subsidiaries and as provided in DFARS 227.7202, DFARS 252.227-7013, FAR 12-212, FAR 52.227-19, or their successors, as applicable.

AVEVA Third Party Software Notices and Licenses: <https://www.aveva.com/en/legal/third-party-software-license/>

Publication date: Thursday, October 19, 2023

Publication ID: 1270591

Contact information

AVEVA Group Limited
High Cross
Madingley Road
Cambridge
CB3 0HB. UK

<https://sw.aveva.com/>

For information on how to contact sales and customer training, see <https://sw.aveva.com/contact>.

For information on how to contact technical support, see <https://sw.aveva.com/support>.

To access the AVEVA Knowledge and Support center, visit <https://softwaresupport.aveva.com>.

Contents

| | |
|---|-----------|
| Chapter 1 Getting Started with AVEVA Enterprise Licensing. | 7 |
| About this Help. | 7 |
| AVEVA Enterprise Licensing Modes. | 7 |
| What is AVEVA Enterprise Licensing?. | 8 |
| AVEVA Enterprise Licensing Workflow. | 9 |
| AVEVA Enterprise Licensing 4.0. | 10 |
| AVEVA Enterprise Licensing Installation. | 11 |
| Installation Requirements. | 11 |
| Requirements to Install AVEVA Enterprise Licensing 4.0. | 12 |
| Installation Procedure. | 12 |
| Installing AVEVA Enterprise Licensing. | 12 |
| Configure license server for the product. | 14 |
| Installing AVEVA Enterprise Licensing Silently. | 17 |
| Upgrading AVEVA Enterprise Licensing. | 17 |
| Uninstalling AVEVA Enterprise Licensing. | 19 |
| Modifying AVEVA Enterprise Licensing. | 19 |
| Repairing AVEVA Enterprise Licensing. | 20 |
| About Activating and Acquiring Licenses. | 20 |
| Using a Trial License. | 21 |
| Key Terms and Concepts. | 21 |
| | |
| Chapter 2 Deploying AVEVA Enterprise Licensing. | 24 |
| Licensing Components. | 24 |
| Organizing License Components into Topologies. | 25 |
| Single Node Topology. | 26 |
| Distributed Topology. | 27 |
| Disconnected Topology | 28 |
| Licensing topology models. | 29 |
| Single Node Topology. | 29 |
| Multiple Nodes - Self-Hosted License Topology - Basic. | 29 |
| Multiple Nodes - Self-Hosted License Topology, Local License Managers. | 30 |
| Multiple Nodes - Centralized Licenses Topology. | 31 |
| Dual Role Multiple Nodes - InTouch Tag-Based Centralized Licenses Topology. | 31 |
| Redundancy Topologies | 32 |
| Multiple Node InTouch Tag-Based Topology - Redundant License Servers. | 33 |

| | |
|---|-----------|
| Multiple Node InTouch Tag-Based Topology - Redundant License Servers and Tag Servers. | 34 |
| Redundant RDS Servers. | 34 |
| Redundant RDS Servers in a Virtualized Environment. | 35 |
| Redundant RDS Servers - Multiple Sessions from One Machine. | 35 |
| High Availability and Disaster Recovery. | 36 |
| High Availability. | 36 |
| Disaster Recovery. | 37 |
| About High Availability and Disaster Recovery. | 39 |
| AVEVA Enterprise Licensing Support for High Availability (HA) and Disaster Recovery (DR) in Virtual Environments. | 40 |
| Implement licensing components. | 40 |
| Configure license server for the product. | 41 |
| About license manager security. | 43 |
| Working with Nodes in Workgroup Network Configuration. | 43 |
| Working with Back-end Applications in a Workgroup Environment. | 44 |
| AE Workgroup Licensing Utility. | 45 |
| Chapter 3 Using AVEVA Enterprise Licensing. | 48 |
| Accessing License Manager. | 48 |
| Navigating License Manager. | 48 |
| Using the License Server Summary Page. | 49 |
| Using the Details Page. | 50 |
| Viewing Details for a Specific License. | 52 |
| Using the Grid Filter. | 53 |
| Activating and Acquiring Licenses. | 54 |
| About Activation and Activation Modes. | 54 |
| Setting the Activation Mode. | 55 |
| Activating Licenses in Online Mode. | 56 |
| Activating Licenses in Offline Mode. | 58 |
| Activating Licenses in Offline Mode Using Two License Managers. | 61 |
| Activating Licenses by Splitting Between Multiple License Servers. | 62 |
| Deactivating Licenses in Online Mode. | 63 |
| Deactivating Licenses in Offline Mode. | 63 |
| Canceling a Pending Offline Activation/Deactivation. | 65 |
| Acquiring Licenses for Backend Applications. | 66 |
| Configuring Permissions for .avevalic File. | 67 |
| Chapter 4 Administering AVEVA Enterprise Licensing. | 69 |
| Administering a License Server. | 69 |
| Adding and Removing a License Server. | 69 |
| Starting and Stopping a License Server. | 70 |
| Renaming a License Server. | 72 |
| License Server Co-located with License Manager. | 72 |
| License Server Remote from License Manager. | 72 |
| Renaming Redundant Servers. | 73 |

| | |
|--|----------------|
| Resetting the License Server ID. | 74 |
| Syncing Licenses. | 75 |
| Syncing Licenses in Offline Mode. | 75 |
| Working With License Server Redundancy. | 77 |
| About License Server Redundancy. | 77 |
| Basic Topology for License Server Redundancy. | 78 |
| Enabling License Server Redundancy. | 78 |
| Monitoring Pair Status Information. | 81 |
| Repairing the Primary Server. | 82 |
| Disabling the License Server Redundancy. | 84 |
| Recovering from Hardware Failure by Re-Imaging Hardware. | 84 |
| Using Command Line License Administration. | 85 |
| Managing the Licensing System in a Virtual Environment. | 86 |
| Managing a License Server on a Virtual Image. | 86 |
| Managing a Licensed Product Virtual Image. | 87 |
| Renaming the License Server Node. | 88 |
| Working with the Grace Period. | 88 |
| Monitoring License Server Health. | 91 |
| Reserving Licenses | 91 |
| Reserving Licenses for Devices. | 92 |
| Exporting and Importing Reservations for Devices. | 93 |
| Canceling, Deleting, or Clearing Device Reservations. | 95 |
| Reserving Licenses for Users. | 96 |
| Exporting and Importing Reservations for Users. | 97 |
| Canceling, Deleting, or Clearing User Reservations. | 98 |
| Checking Out Licenses. | 99 |
| Checking Out Licenses using License Manager. | 99 |
| Checking Out Licenses using the Checkout Utility. | 100 |
| About Checkout Utility. | 100 |
| Checkout Utility Commands. | 100 |
| Security Requirements. | 101 |
| Using the Checkout Utility. | 101 |
| Dropping Devices. | 102 |
| Setting Product Compatibility. | 103 |
| Monitoring License Usage. | 103 |
| About Monitoring License Usage. | 104 |
| Viewing License Usage Summary Information. | 105 |
| Viewing License Usage Detail Information. | 106 |
| About Changing Default Port Settings. | 107 |
| Changing the Default License Server Core Service Port. | 109 |
| Changing the Default License Server Agent Port. | 110 |
| Updating Ports on License Manager Nodes. | 112 |
| Updating Ports on Product Nodes. | 114 |
| Changing Ports for Product License Service. | 114 |
| Opening a Port in Your Firewall. | 117 |
| Chapter 5 Troubleshooting and FAQs. | 118 |

| | |
|--|------------|
| Diagnosing Licensing Issues. | 118 |
| Diagnosing Licensing Issues using Log Messages. | 118 |
| License Server Issues and Solutions. | 120 |
| License Activation Issues and Solutions. | 122 |
| Acquiring Licenses Issues and Solutions. | 123 |
| License Reservations Issues and Solutions. | 126 |
| Grace Period Issues and Solutions. | 127 |
| Miscellaneous License Management Issues and Solutions. | 127 |
| AVEVA Enterprise Licensing FAQs. | 129 |
| | |
| Chapter 6 Glossary. | 130 |

Chapter 1

Getting Started with AVEVA Enterprise Licensing

About this Help

The AVEVA Enterprise Licensing Help topics are organized into the following categories, grouped by licensing operations:

- **Getting Started with AVEVA Enterprise Licensing:** Introductory information about AVEVA Enterprise Licensing.
- **Deploying AVEVA Enterprise Licensing:** Topology concepts and models to design the system to use the licensing components.
- **Using AVEVA Enterprise Licensing:** Basic licensing functions, such as navigating the License Manager interface and activating licenses.
- **Administering AVEVA Enterprise Licensing:** Advanced licensing operations that may be performed by an administrator.
- **Troubleshooting:** Different recommended solutions for possible licensing issues.
- **Glossary:** An alphabetical list of terms used in this document, with a brief explanation of each term.

AVEVA Enterprise Licensing Modes

AVEVA Enterprise Licensing is available in two modes:

- **Perpetual mode:** In this mode, you purchase a particular product in perpetuity
- **Flex mode (subscription-based):** In this mode, you subscribe to a range of AVEVA products on a recurring basis.

As a Flex customer, you are required to purchase Flex credits. These credits are used to consume licenses for any of AVEVA's cloud, hybrid, or on-premise products for a definite period. The credits are consumed according to the rate plan of the software you use.

The AVEVA Enterprise License Manager and License Server manage perpetual licenses. Flex licenses are managed on the AVEVA Flex portal. For more information on Flex, see [AVEVA Flex | Flexible Industrial Software Subscription | AVEVA](#).

What is AVEVA Enterprise Licensing?

The AVEVA Enterprise Licensing system is a common platform that allows you to effectively and efficiently manage AVEVA Enterprise Software product licenses. This licensing system is composed of a browser-based License Manager and a License Server that together allow you to share and deliver licenses for your installed products. This licensing system allows centralized license management, eliminates the need for dongles, and increases license security by use of Activated licenses. It supports flexible topologies for any size of system.

This document provides a summary of the licensing process and licensing related recommendations for different topologies.

The AVEVA Enterprise Licensing system is supported on the following web browsers:

- Internet Explorer version 10 and later
- Google Chrome versions later than 32
- Mozilla Firefox versions later than 27
- Microsoft Edge

Note: Microsoft Edge does not support single sign-on. Using Microsoft Edge will prompt you to sign in with your Windows credentials before launching License Manager.

The following describes the components of the AVEVA Enterprise Licensing system.

License Manager

The License Manager allows you to quickly access and maintain licenses for certain AVEVA Enterprise Software products in your different environments using its scalable, flexible design features:

- Browser-based for scalability and ease of use; can be remotely accessed by any of the supported web browsers.
- Light-weight, standalone software you can install on the same node as the License Server computer, or on any other node based on your deployment needs.
- Manage one or multiple License Servers to best organize and manage the licenses in your unique environment.
- Access details about your licenses, such as usage information, from the License Manager interface.

License Server

License Server provides all the functionality to acquire, store, maintain, and serve licenses to your installed AVEVA Enterprise software.

- Licenses are hosted and maintained on the License Server.
- Securely serve any type of software applications being licensed, including Windows browsers, tablets, and mobile devices.
- Provide current license usage information.

Activation Server

Activation server is a cloud-based Internet-accessible server to which the License Manager connects for license activation. The License Manager connects to the AVEVA Activation Server in the Cloud only temporarily during the activation process.

Additional functional components and concepts are described under the [Key Terms and Concepts](#) section.

Installed Products

Once the AVEVA Enterprise Software product is installed it relies on the licensing system to enable its functionality. During product installation you decide from which License Server you want the product to get its license. If a License Server is installed on the same computer as the product, it will use that one as the default. If the product is installed on a different computer than the License Server, you can point the product to License Server computer. All the products installed on the same computer would point to the same License Server.

AVEVA Enterprise Licensing Workflow

This section describes the licensing workflow. This example assumes that both License Manager and License Server are installed on the same computer, and that the computer can connect to the Internet.

1. **Purchase one or more AVEVA Enterprise Software products:** Along with your installation media or downloads, you will receive one or more entitlement files containing license details.
2. **Start License Manager:** It opens in a browser window and accesses the installed License Manager components.
3. **Select the License Server:** Use the License Manager to select an available server to host the licenses you want to activate. You can also add a new license server.
4. **Import the entitlement file:** Import the [entitlement file](#) (). Once imported, the License Manager displays the available licenses.

The entitlement file contains information for specific product licenses that are imported into the License Manager to activate purchased licenses. It is sent to you in an email upon purchase of your product licenses. It is in a zipped .xml file format.

5. **Activate licenses:** License Manager connects to the AVEVA Enterprise Activation Server over the Internet to activate the selected licenses on the License Server.
The Activation Server activates licenses on the License Server.
6. **Manage your licenses:** Licenses are now available for their respective product to use. You can now:
 - activate new licenses
 - deactivate current licenses
 - reserve and unreserve licenses
7. **Install and Configure the purchased products:** Install your purchased AVEVA Enterprise Software products following the individual product installation instructions. The installed products, when running, will acquire their licenses from the License Server and will release them when no longer needed.

The following diagram shows the relationships between the licensing components in a single node system, but the workflow applies to all network topologies.

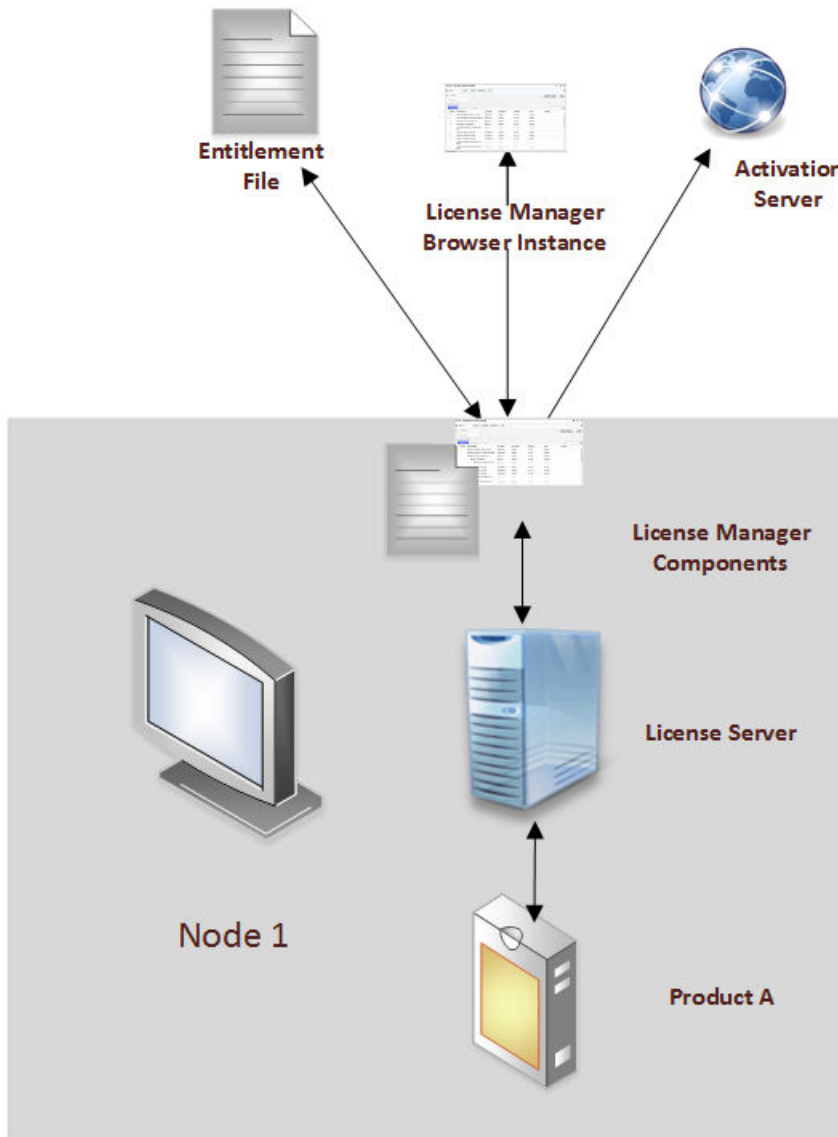

AVEVA Enterprise Licensing 4.0

AVEVA Enterprise Licensing 4.0 is the latest version of the Licensing system.

The Platform Common Services (PCS) framework is required for AVEVA Enterprise Licensing 4.0 to run in secure mode.

When you install/upgrade Licensing 4.0 components on a machine with the PCS framework already installed, the Licensing components (License Server and License Manager) are automatically configured in secure mode.

Without PCS, the licensing system runs in unsecure mode. This is not recommended, as the licensing system will be vulnerable.

AVEVA Enterprise Licensing Installation

The AVEVA Enterprise Licensing system is a common platform that allows you to effectively and efficiently manage AVEVA Enterprise Software product licenses. It is composed of a browser-based License Manager and a License Server that together allow you to share and deliver licenses for your installed products.

You can install AVEVA Enterprise Licensing with AVEVA Enterprise products or you can install just the Licensing system as a standalone. You can install standalone versions of the following types:

- Clean Install - License Manager only: installation on a machine with no previous installation of License Manager.
- Clean Install - License Server only: installation on a machine with no previous installation of License Server.
- Clean Install - License Manager and the License Server together: installation on a machine with no previous installation of License Manager or License Server.
- [Upgrading AVEVA Enterprise Licensing](#)
 - Installation done on a node that has AVEVA Enterprise License Manager of any version
 - Installation done on a node that has AVEVA Enterprise License Server of any version
 - Installation done on a node that has AVEVA Enterprise Licensing of version greater than or equal to 3.0

Installation Requirements

This section describes the operating system, hardware, and software requirements to install AVEVA Enterprise Licensing.

Supported Operating Systems

- Client Operating System (x86 and x64):
 - Windows 8.1 Professional
 - Windows 10 Version 1607
- Server Operating System (x64 only):
 - Windows Server 2012

.NET Requirement

AVEVA Enterprise Licensing requires .NET Framework 4.8. The licensing installation process checks if .NET version 4.8 is installed. If not, you are prompted to allow .NET installation.

Note: A system restart is required when .NET installation is complete. If the licensing installation does not automatically resume after the system restart, you can restart it manually.

Hardware Requirements

- CPU Cores: 4
- RAM: 4 GB

Software Requirements

- A clean installation of License Manager and License Server requires .NET Framework 4.8.
- An upgrade Installation of licensing components requires a software product installed that uses licensing.
- Upgrading to the secure license server requires the PCS framework.

Requirements to Install AVEVA Enterprise Licensing 4.0

In order to install AVEVA Enterprise Licensing 4.0., ensure that the following requirements are met:

1. Ensure that the Platform Common Services (PCS) framework is present on the machine.
2. Configure the System Management Server (SMS) from the Common Platform.
3. Configure the certificate.
 - PCS-managed certificates expire after 18 months.
 - If you are using System Management Server-managed certificates, this will need to be done before the "Start Time" on the services reaches "18 months ago".
 - If you are using IT-managed certificates, check with your IT department for information about certificate expiry.

Ensure that the same certificate is placed on all nodes that have AVEVA Enterprise Licensing 4.0 components installed.

Note: All nodes using licenses must use the same SMS, therefore, install and configure only one SMS. Refer to the System Platform Installation Guide for more details.

Best Practices

We recommend the following steps to use AVEVA Enterprise Licensing 4.0 in secure mode:

- Install the System Management Server (SMS) on the same node as the license server.
- Install PCS and SMS on all nodes, but configure only one SMS, as all nodes with licenses should be connected to the same SMS.

Installation Procedure

This section describes the steps involved to install AVEVA Enterprise Licensing.

Installing AVEVA Enterprise Licensing

Note: All installed products should be shut down before upgrading. This will release all the licenses so that when the products are re-started licenses will be acquired correctly.

To install the AVEVA Enterprise Licensing standalone

1. Locate and right-click the **setup.exe** file and then select **Run as administrator**.
The **License Agreement** screen appears.
2. Accept the **End User License Agreement** and then click **Next**.
3. Select the components that you want to install:

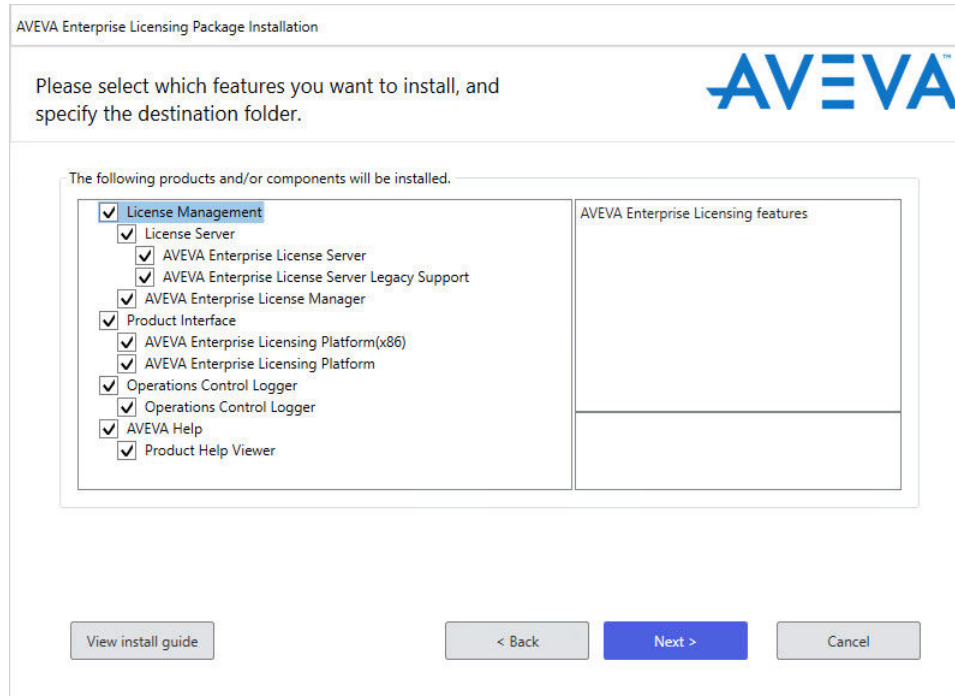

- Select **License Management** to install only both the license server and license manager on the same node
- Select **License Server** to install the license server on the node.
 - Select **AVEVA Enterprise License Server** to install the secure license server.
 - Select **AVEVA Enterprise License Server Legacy Support** to allow support for legacy versions of Licensing on client nodes. If this checkbox is not selected, all client nodes that connect to this License Server would need to be upgraded to 4.0.

Note: When you upgrade to AVEVA Enterprise Licensing 4.0 from an older version, the **AVEVA Enterprise License Server Legacy Support** checkbox is unselected by default, as it is recommended that all client nodes be upgraded to 4.0.

- Select **AVEVA Enterprise License Manager** to install the license manager on the node.
- Select **Product Interface** to install the Licensing API components. When upgrading, the **Licensing API** components that you previously installed with the product are selected automatically and are upgraded.

If an older version of the Licensing API is not installed, then the **Licensing API** option will be disabled and will not be selected to install.

- Select the **Operations Control Logger**.
- Select **AVEVA Help** to install the Product Help Viewer. This is required to access the AVEVA Enterprise Licensing Help.

4. Click **Next**.

The **Ready to Install the Application** screen appears.

5. Click **Install** to start the installation.

Once the installation is complete, the **Installation successful** dialog box appears.

6. Click **Finish**.
7. Configure the License Server as needed:
 - If you install License Manager only - the Configurator will not appear after installation. You will need to add a license server when you start the License Manager.
 - If you install License Server only - the Configurator will not appear after installation.
 - If you install License Manager and License Server on a clean machine - the Configurator will not appear after installation. The License Manager automatically adds the local installed server by machine name.
 - If you upgrade, the Configurator appears after the installation is complete. Server configuration for the previously installed version of AVEVA Enterprise Licensing will be valid in most cases. Reconfigure the server name, server port, and redundancy as needed.

Configure license server for the product

After completing the installation of your product, you need to define the location of the License Server that will host the licenses for the product.

To use the Configurator

A configuration tool is available at the end of the product installation process by clicking a **Configure** button.

Note: You can access the **Configurator** at any time post-installation to complete or modify your configuration by going to the Windows **Start** menu and clicking **Configurator**.

By default, the installation process identifies the local computer as the License Server name, and provides the default server port. Port 55559 and 59200 are the default ports for License server and can be configured.

Important: Before running the **Configurator**, make sure that the ports 55559 and 59200 are open.

To configure AVEVA Enterprise Licensing

1. Start the **Configurator**.
2. On the left navigation pane, expand **AVEVA Enterprise Licensing** , and select **Secure**.
The configuration screen appears.

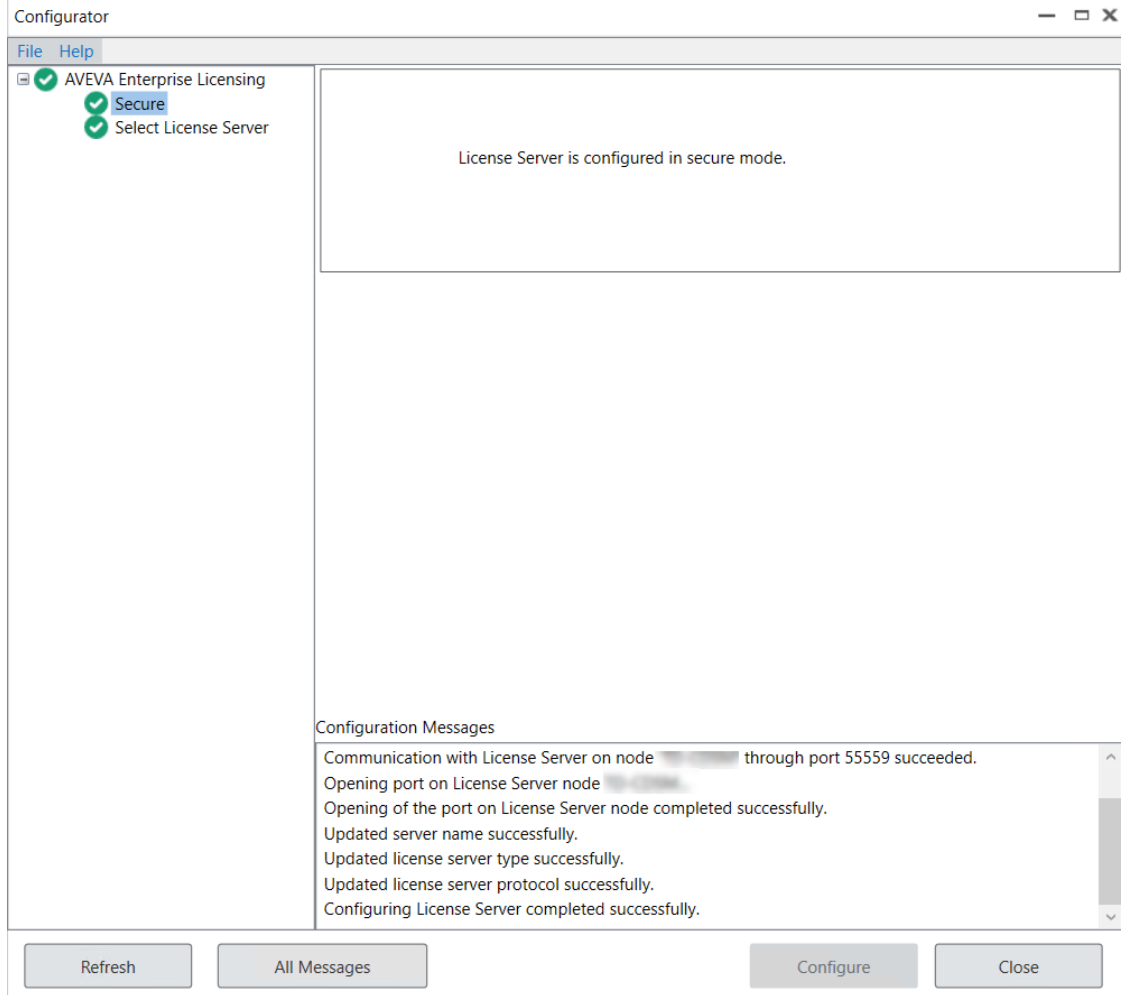

3. Click **Configure**.

License Server is successfully configured in secure mode.

4. In the left navigation pane, expand **AVEVA Enterprise Licensing** , and select **Select License Server**.

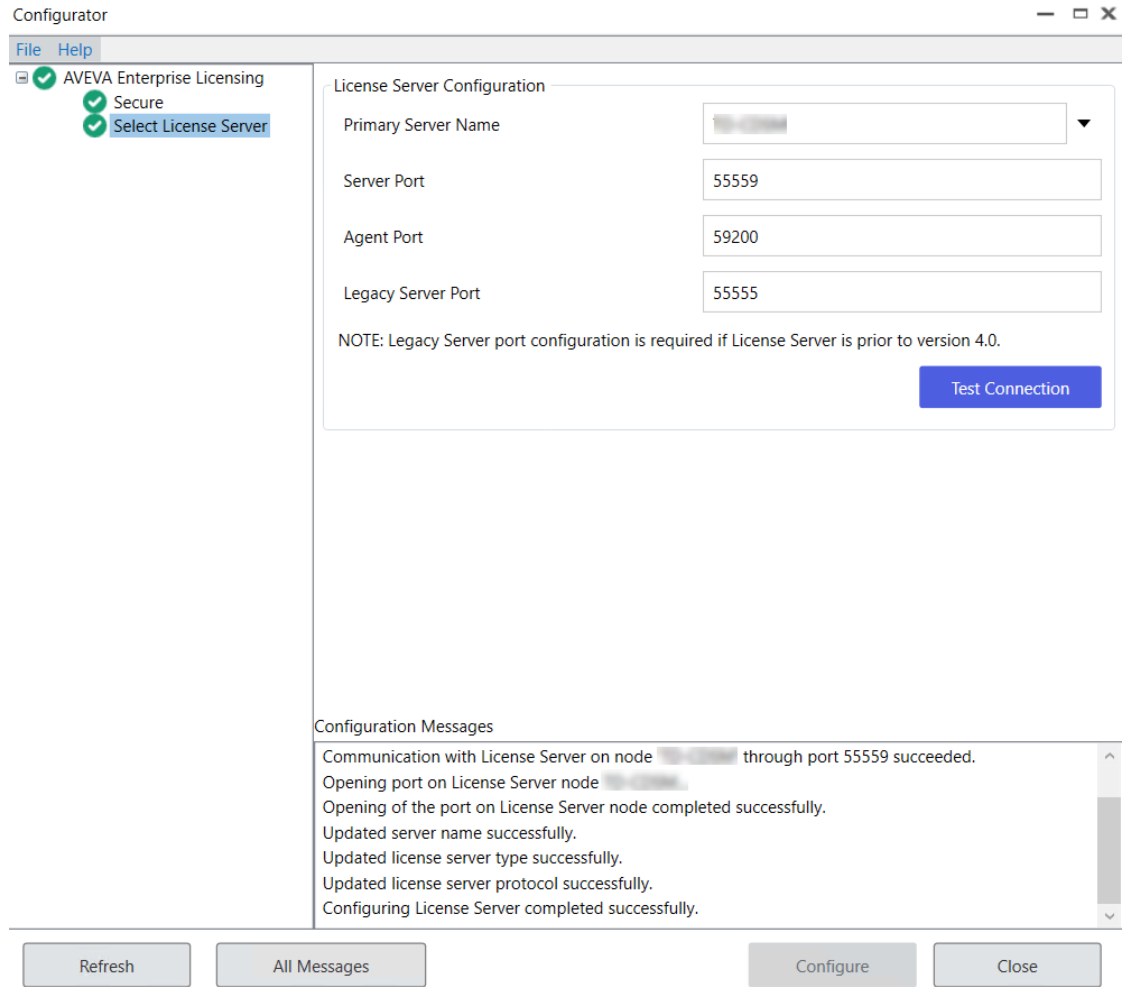

Then, in the right pane enter:

- **Primary Server Name:** if the License Server is not installed on the local node, enter the License Server name, or select a server name from the drop down list of previously-configured License Servers (if any).
-
- Note:** This is the IP address/machine name of the server that hosts the relevant licenses.
-
- **Server Port:** Enter the server port number. The default port number is 55559.
 - **Agent Port:** Enter the license server agent port number. The default port number is 59200 (for WCF communication) or 59201 (for gRPC communication).
 - **Legacy Server Port:** Enter the legacy license server port number. The default port number is 55555.

Note: **Legacy Server Port** configuration is required if License Server is prior to version 4.0.

5. Click **Test Connection** to verify the details are correct.

If the connection test succeeds, go to step 6.

If the test fails, messages indicating errors are highlighted in the **Configuration Messages** box. Verify your information and repeat the test.

6. Click **Configure**.

The license(s) are released from the host machine.

Note: You can configure the License server even when the specified primary server is unavailable.

For more information on configuring license server redundancy, refer to [Enabling License Server Redundancy](#)

Installing AVEVA Enterprise Licensing Silently

If you are installing AVEVA Enterprise Licensing to multiple computers, you can run the installation "silently" (command line mode).

Installing AVEVA Enterprise Licensing Silently from the Command Line

1. Open the command prompt (**cmd.exe**) as Administrator.
2. Change the working directory to the folder where you downloaded AVEVA Enterprise Licensing **Setup.exe**.
3. Run one of the following commands, depending on whether or not you want the computer to reboot automatically:
 - To automatically restart the node when installation is complete, enter the following command:
`"C:\...\CD-AELicensingPackage\Setup.exe" /silent "C:\Response.txt"`
 - If you do not want to automatically restart after installation, use the **/Silentnoreboot** option:
`"C:\...\CD-AELicensingPackage\Setup.exe" /silentnoreboot "C:\Response.txt"`

Note: If you do not require Configurator as a part of Silent Installation, then you can navigate to **All.txt** file located in **CD-AELicensingStandalone\SampleResponseFile** and delete the section containing the **<Configurator>** tags.

Upgrading AVEVA Enterprise Licensing

You can verify the version of License Manager by navigating to **Control Panel** and selecting **Programs and Features**. The installed AVEVA Enterprise License Manager, AVEVA Enterprise License Server, or AVEVA Enterprise Licensing (licensing platform components) version displays in the **Version** column.

Note: Licensing platform components are installed with every product, whether or not a License Manager or a License server are installed on that node. These components display in **Programs and Features** as "AVEVA Enterprise Licensing" for both 32-bit and 64-bit systems.

The following table describes different upgrade scenarios of AVEVA Enterprise Licensing to the latest available version. In some upgrade scenarios, licenses will enter the grace period. You can resume normal licensing functionality when the grace period ends. Refer to AVEVA Enterprise Licensing Help, [Working with the Grace Period](#) for more information.

| Product Node Upgrade Scenarios | Description |
|---|---|
| Upgrade a product on the same node as an installed version of License Manager of earlier version. | License Manager and the AVEVA Enterprise Licensing components will upgrade to the latest version automatically. |

| | |
|---|--|
| Upgrade a product on the same node as an installed version of License Server of earlier version. | License Server and the AVEVA Enterprise Licensing Components will upgrade to the latest version automatically. |
| Upgrade a product on the same node as installed versions of both License Manager and License Server of earlier version. | License Manager, License Server, and the AVEVA Enterprise Licensing Components will upgrade to the latest version automatically. |
| Upgrade a product on a node that has no License Manager or License Server installed. | The AVEVA Enterprise Licensing components will upgrade to the latest version automatically. Will not result in an automatic upgrade of License Manager and License Server installed on remote nodes. You must upgrade your License Manager and License Server separately on the node where each is installed. |
| Upgrade to the latest version in Hyper-V and Azure virtual machines. | The license server will enter the Grace Period upon upgrade. End this grace period by syncing the licenses in the License Server. Important Note: To avoid entering the Grace Period, deactivate all licenses on the license server prior to upgrade in this scenario. |
| Licensing Version Upgrade Scenarios | Description |
| Upgrade from version 3.0 to the latest version. | The license server will enter the Grace Period upon upgrade. End this grace period by syncing the licenses in the License Server. Important Note: To avoid entering the Grace Period, deactivate all licenses on the license server prior to upgrade in this scenario. |
| Upgrade - from all versions to all versions. | If the license server is in a Grace Period prior to upgrade, it will remain in Grace Period following upgrade. To end the Grace Period after upgrading, you will need to contact Technical Support to obtain a Grace Period exit code. To avoid this scenario, end the Grace Period before upgrading to a newer License Server version. The license server will not enter a Grace Period upon upgrade. |

Note: You can resume normal licensing functionality once the Grace Period has ended. Since all licenses should be removed from the server prior to ending the Grace Period, no licenses will be lost due to this action.

To upgrade AVEVA Enterprise Licensing

Note: All products should be shut down before upgrading. This will release all the licenses so that when the products are started licenses will be acquired correctly.

1. Right-click the **setup.exe** file and select **Run as administrator**.
An alert message with the list of products that will be upgraded appears.
2. Click **OK**.
The **License Agreement** screen appears.
Follow the steps from step 2, in the [Installing AVEVA Enterprise Licensing](#) section.

Upgrading the License Server

After you upgrade to AVEVA Enterprise Licensing 4.0 from an older version, a **License Server Migration** pop-up appears when you launch the License Manager.

Select the **Migrate** button to ensure that all data is migrated to the latest version.

Uninstalling AVEVA Enterprise Licensing

Note: You cannot uninstall the product licensing if there is a product currently installed or when other products are currently using it.

To uninstall an AVEVA Enterprise Licensing Component

1. Click the **Uninstall or Change a Program** option in Windows **Control Panel**. The list of software installed on your computer appears.
2. Select the AVEVA Enterprise Licensing component that you want to uninstall, and then click **Uninstall/Change**. The **Modify, Repair or Remove Installation** dialog box appears.
3. Click the **Remove** option, and then click **Next**. The confirmation dialog box appears.
4. Click **Uninstall**. The component is uninstalled, and the complete uninstallation dialog box appears.
5. Click **Finish**.

Modifying AVEVA Enterprise Licensing

You can change the AVEVA Enterprise Licensing components installed on your computer. You can add new components or remove the existing ones. You can modify any component of AVEVA Enterprise Licensing.

Note: You must have the installation media ready before you can modify a program.

To modify an installation

1. Select the **Modify** option from the AVEVA Enterprise Licensing **Modify, Repair or Remove Installation** dialog box. You can open the dialog by doing either of the following:
 - Run Setup.exe from the AVEVA Enterprise Licensing installation media.
 - Navigate to **Uninstall or Change a Program** in the Windows **Control Panel**. Then, select any AVEVA Enterprise Licensing component and then click **Uninstall/Change**.

Note: The name of the **Uninstall/Change** option may vary depending on which Windows operating system is installed on your computer.

2. Click the **Modify** option, and then click **Next**. The list of AVEVA Enterprise Licensing components appears.
3. Select or clear the components that you want to add or remove, and then click **Next**. The verify change dialog box appears.
4. Click **Modify**. The selected components are added or removed and the complete modification dialog box appears.
5. Click **Finish**.

Note: The system may not prompt you to restart the system after Modify is successful. However, if you have added a new product or feature, a system restart is recommended.

Repairing AVEVA Enterprise Licensing

You can repair the installation of any component of the AVEVA Enterprise Licensing. You can repair missing or corrupt files, registry keys or shortcuts. You can also reset the registry key to the default value.

Note: You must have the installation media ready before you repair a program.

To repair an installation

1. Click the **Uninstall or Change a Program** option in Windows **Control Panel**. The list of software installed on your computer appears.
2. Select the AVEVA Enterprise Licensing component that you want to repair, and then click the **Uninstall/Change** button. The **Modify Repair or Remove Installation** dialog box appears.

Note: The name of the **Uninstall/Change** button varies depending on the Windows operating system installed on your computer.

3. Click the **Repair** option, and then click **Next**. The **Confirm Repair** dialog box appears.
4. Click **Repair**. The **complete repair** dialog box appears.
5. Click **Finish**.

About Activating and Acquiring Licenses

License Manager and License Server are installed as part of the installation process of your purchased products. The Activation Server is not installed on your local computer or network. These components work together to provide licensing for your installed products.

License Activation (see [Activate \(a license\)](#) on page 130) is the process of enabling a purchased license on a License Server for use by a product. The Activation Server takes an Activation ID, validates it, and provides an activated license in return.

Acquiring a license (see [Acquire \(a license\)](#) on page 130) occurs when an install product is started. An installed product, when running, acquires its activated license from the License Server and releases it when no longer needed.

This section provides an overview of how license activation works. For both activation modes, the license entitlement file must be copied to the target computer where License Manager components are installed, or to a location on your network where the target computer can access it.

You can use a trial license for a given product for try-out and testing purposes.

For detailed information and procedures regarding trial licenses, installation and activation, see [Using a Trial License](#).

Online Activation

Online activation provides the means to activate licenses when there are no internet restrictions in your environment. This mode is configured by default in the **Activation Settings** menu.

For online activation to work, make sure that the License Manager has connectivity to both the License Server, typically via an intranet, and to the Activation Server via the Internet.

Video Tutorial: Online Activation



Offline Activation

Offline activation provides the means to activate licenses when the Internet connection to the Activation Server is restricted to certain areas in your environment.

In this mode there are two nodes involved to complete the activation process:

- A node with License Manager components installed and network access to a License Server but no Internet access to the Activation Server. The **Offline Activation** mode must be selected in the **Activation Settings** menu.
- A node with Internet access to the Activation Server and License Activation Web Page.

Video Tutorial: Offline Activation



Using a Trial License

A trial license allows you to use the associated product for a limited period of time to try out and test the product. Typically, a trial license is a binary file, for example, "trial.bin".

To use a trial license for a given product, place the binary license file at the following path:

```
%ProgramData%\AVEVA\Licensing\TrialLicensePool
```

You can then use the product directly, without using the License Manager to activate the license. The product will run until the indicated expiry date on the trial license file.

Note: Trial licenses are not visible in the License Grid of the License Manager.

Key Terms and Concepts

The following table describes the key terms and concepts of AVEVA Enterprise Licensing.

| Term | Description |
|----------------------|---|
| License Server Node | Computer or VM where the License Server software is installed and running. |
| License Manager Node | Computer or VM where the License Manager software is installed and running. |
| Entitlement File | An XML file that contains the Activation IDs which enable specific product software functionality. |
| Entitlement ID | A unique identifier that groups all licenses from a single order together. This unique identifier is also the file name of the Entitlement file. Example: DEV10200-int-2017A |
| Activation ID | A code that enables the activation of a specific product license. |
| License Activation | License Activation is the process of enabling a purchased license on a particular License Server for consumption by a product. Activation process can be done Online (typical) or Offline (a standalone License Server node that does not have access to the Internet). |
| License Reservation | Licenses can be reserved for a particular device, or left unreserved. The reserved license model ensures that specific devices are assigned a license and can be acquired only by that device. An available unreserved license can be acquired by any device without a reservation. Once all unreserved licenses are acquired, any new license requests will be denied. |
| Online Activation | Online activation provides a workflow to activate your licenses when a system has access to the Internet and it can reach the AVEVA Activation Server. Online Activation is the default mode. |
| Offline Activation | Offline activation provides a workflow to activate licenses when a system does not have access to the Internet and thus to the AVEVA Activation Server. |
| Request File | A License Manager generated file (*.sync) containing activation information used in the Offline Activation mode for the Activation Server to activate a license. |

| Term | Description |
|----------------|--|
| Response File | An Activation Server generated file (*.recv) containing license rights for activation used in the Offline Activation mode in order to complete the activation process. |
| Borrowed Time | If a node does not or cannot communicate with the License Server to renew the license, then it will expire after certain time. This time duration is called borrowed time. |
| Grace Period | On the virtual image, if you try to clone or copy image of a License Server, the licenser server will enter a grace period. The grace period allows you to continue performing normal licensing functions for 15 days. After the 15 day Grace Period, the License Server will no longer serve licenses. You will need to update the licenses on the cloned or copied image within this time. |
| Redundancy | You can configure your system for high availability (HA) and disaster recovery (DR) using the license server redundancy features. For more details on how to setup redundancy, see " Working With License Server Redundancy " in AVEVA Enterprise Licensing help. |
| Virtualization | You can configure your licensing platform using commercially available virtual machines as part of your topology. For more details on how to set up a virtualized environment, see " Managing the Licensing System in a Virtual Environment " section in the AVEVA Enterprise Licensing online help. |

Chapter 2

Deploying AVEVA Enterprise Licensing

Licensing Components

The main components of the AVEVA Enterprise software licensing system are described in the following. Use the topology concepts and models in this section to design your system, then follow the guidelines and procedures to install and configure the licensing components.

License Server

The License Server handles all server functions related to managing licenses. The License Server:

- Hosts the licenses that enable the product to operate.
- Controls a set of services that handle the activation and deactivation of licenses.
- Provides license usage information.

For more information about managing License Servers, see [Administering a License Server](#).

License Manager Application and Components

You use the License Manager browser-based application to administer License Servers and their associated licenses. The easy-to-use License Manager runs within a secured session in an Internet browser. Using License Manager, you can:

- Activate licenses as new products are included in the topology. License Manager interacts with both the License Server and the Activation Server to complete the activation. For information, see [About Activation and Activation Modes](#).
- Get detailed information on how the licenses are used by the products. For information, see [Monitoring License Usage](#).

The License Manager components include the web services required to handle the interaction between the License Server and the Activation Server. The License Manager components must be installed on at least one node or computer that has Internet access to the Activation Server in order to activate licenses. You can run the License Manager application remotely from the node where the License Manager components are installed.

Access License Manager by opening the following URL in your browser:

```
https://<nodename>\AELicenseManager
```

where <nodename> is the name of the node where the License Manager is installed.

Activation Server

The Activation Server is an Internet-based server that:





- Creates entitlements.
- Processes license activation and deactivation requests.
- Associates licenses with their corresponding License Servers.
- Keeps track of activated licenses.

The Activation Server is only accessed by the License Manager for license activation and deactivation purposes. The Activation Server is hosted in the cloud by AVEVA Enterprise Software and is not deployed to your network topology.

Note: There are no permanent connections between the installed license components and the Activation Server.

Visual Elements Used in Topology Diagrams

The following visual elements appear throughout the topology diagrams in this section to represent licensing components.

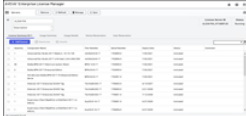
| Symbol | Description |
|---|--|
|  | License Manager |
|  | License Server |
|  | Installed product(s) |
|  | Activation Server - hosted by AVEVA in the cloud License activation is provided by a cloud-based server in all topologies |
|  | License Manager, remote or local browser user interface |

Organizing License Components into Topologies

AVEVA Enterprise Licensing is scalable and flexible. You can set up single-node or multiple-node systems. The information, guidelines and topology models in this section are provided to assist in designing and then implementing a topology that matches your working environment.

You can create a topology of two general types:

- Single node topology
- Distributed topology

A third type is actually a subset of these - the disconnected topology. This is any topology where an internet connection is not available. Each of these general types of topologies is described in the following topics. The topology models topics then go into greater detail of the different topologies you can use to deploy your system. See [Licensing topology models](#).

The License Server and License Manager are delivered with the AVEVA Enterprise software products as independent components to allow you to deploy them to the nodes where they fit your requirements.

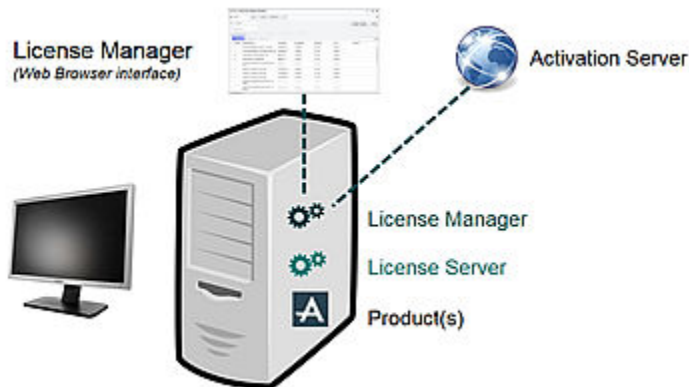

In this sample topology, a single node system, the product machine has both the License Server and License Manager components.

The components of the product interact with the License Server. The product component acquires and releases activated licenses in the License Server to enable product functionality and client connectivity.

Guidelines for Designing and Implementing Your Licensing System

1. When centralizing licenses in a License Server:
 - a. If you have multiple licenses for the same product with the same functionality hosted in the same License Server, reservations are not needed.
 - b. If one or more licenses for the same product have unique functionality, then reservations are needed to ensure that those unique licenses are acquired by the proper node(s).

 For example, if you host five InTouch 5K Run-Time licenses in a License Server and you have five InTouch nodes, no reservations are required. Any node can acquire any license.

 If you host four InTouch 5K Run-Time licenses and one InTouch 60K Run-Time license and you have five InTouch nodes, then you must reserve the 60K Run-Time license for the node that must acquire it to ensure only that node can use it.
2. The System Platform installation allows you to install the License Server, the License Manager, or both. These can be installed in separate machines or all in a single node.

 Consider the best location to install them based on your topology and system needs.
3. If you chose to centralize your licenses in one License Server, always leverage the License Server Redundancy capability. License Server redundancy capability is available at no additional cost.
4. When working with virtualized environments, be sure to deactivate all licenses in a License Server before cloning a VM. If this is not done, the cloned License Server will go into Grace Period mode of 15 days, after which it will cease serving licenses.

Single Node Topology

The Single Node Topology is a single computer with the purchased product (in this case, the Product Server components), License Manager, and License Server installed, with an available Internet access to the Activation Server.

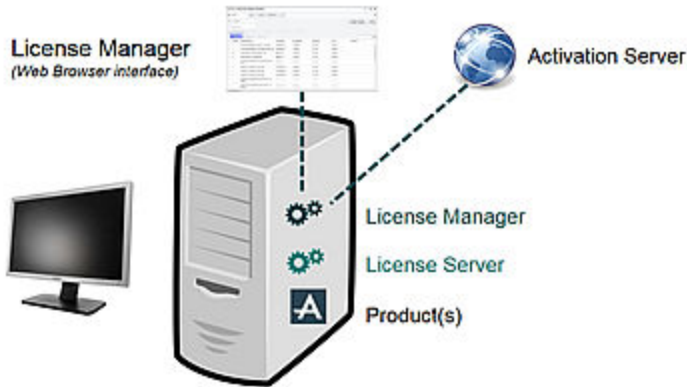

In this configuration, the communication between the product server components, License Server, and License Manager is local.

If the node has Internet access to the Activation server the licenses can be activated/deactivated in "Online" mode. If this node does not have access to the Internet then a separate node with Internet access to the License Activation Web Page and Activation Server needs to be set up to complete the activation process. See [Activating Licenses in Offline Mode](#) for details.

Distributed Topology

The licensing components can be installed on separate nodes as long as there is reliable network connectivity between them. Distributing the licensing components across nodes may help optimize resource usage. This topology is best suited for systems where the License Server manages licenses for multiple products.

In the following example, the License Manager components are installed on one computer with Internet access to the [Activation Server](#) (), the License Server is installed on a second computer, and product components are installed on separate computers, each with network access to a License Server.

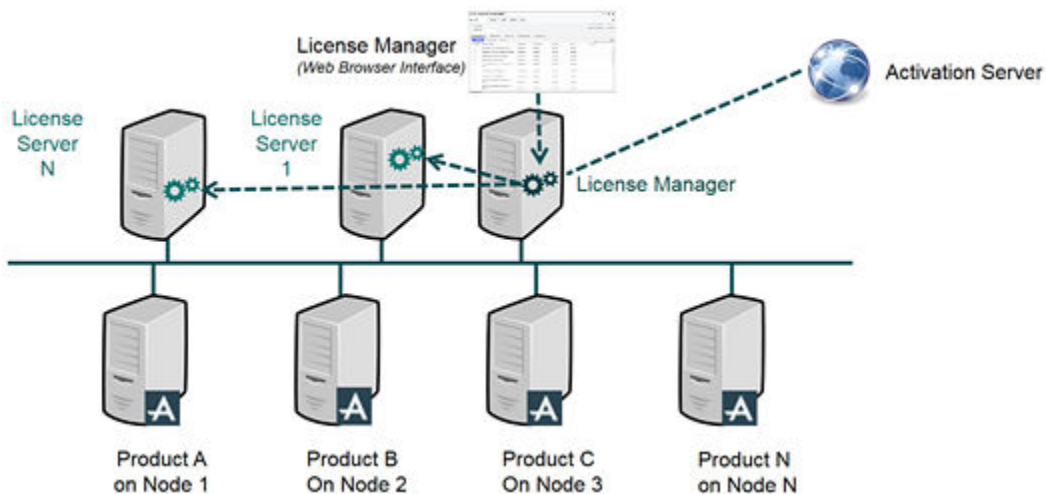

If you are implementing a distributed topology, we recommend creating a network diagram as a first step, to visually model the system before installing the License Manager and License Server.

If the node where the License Manager components are installed has internet access to the Activation Server, you can activate/deactivate the licenses using the "online" mode. For more information, see [Activating Licenses in Online Mode](#).

If this node does not have access to the Internet, then you must set up a separate node with Internet access to the License Activation Web Page and Activation Server to complete the activation process. For more information, see [Activating Licenses in Offline Mode](#).

Disconnected Topology

One computer must have Internet access to the License Activation Web Page and Activation Server in order to complete the activation. However, your environment might not support this and you will have to work around the disconnect.

A disconnected topology can have the following characteristics:

- The License Manager node has network access to the License Server.
- A firewall or any constraints exist between the License Manager components and the Activation Server.

In this scenario, you must set up a separate node with Internet access to the License Activation Web Page and Activation Server and then complete the activation process in "offline" mode. For more information, see [Activating Licenses in Offline Mode](#).

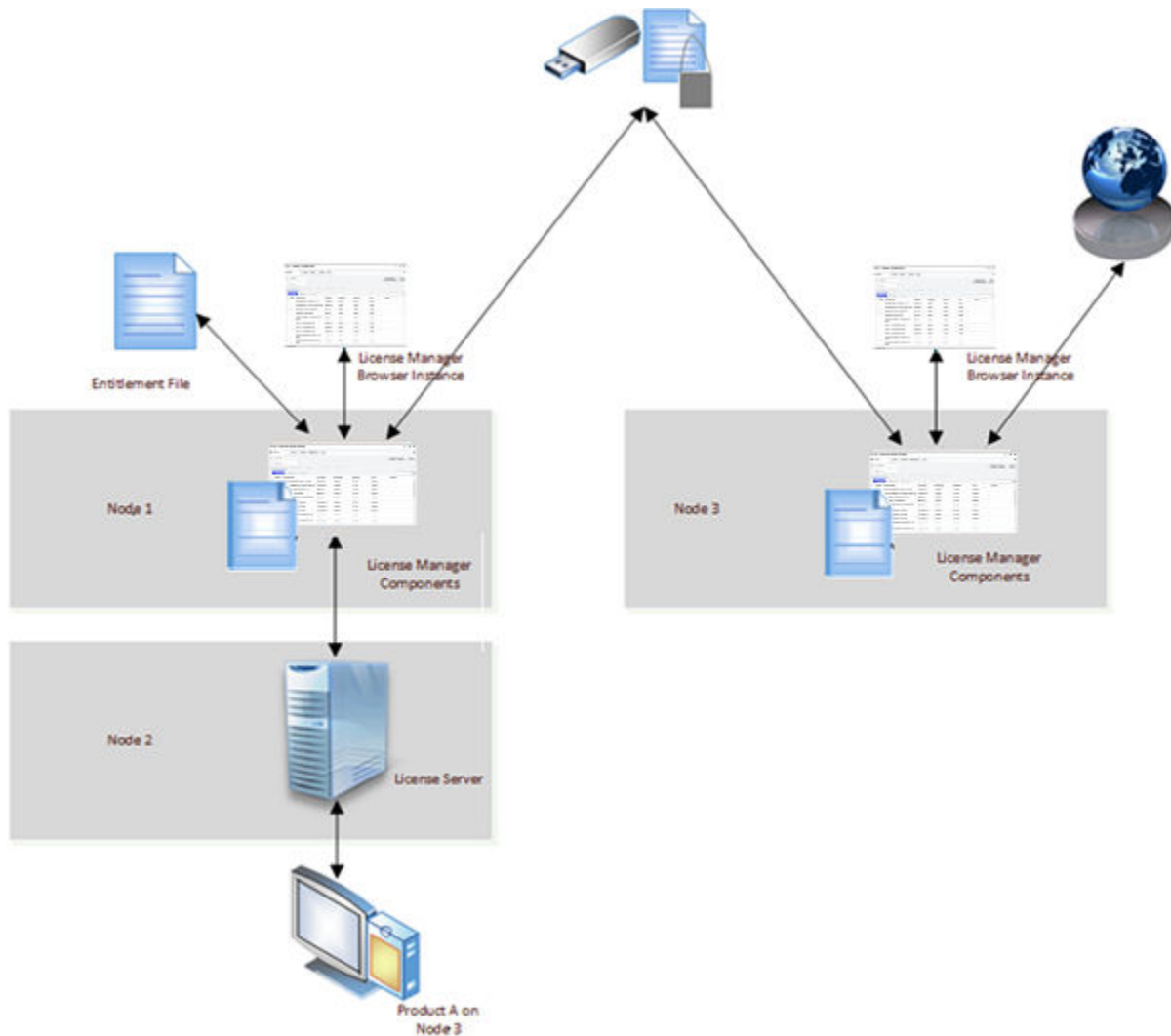

Licensing topology models

Use the models provided in this section to design and deploy an AVEVA Enterprise Licensing platform that most closely matches your own enterprise's topologies and requirements.

Single Node Topology

In a single node "all in one" topology, the License Server, License Manager, product software, license(s) and web browser are hosted on the same machine. The Activation Server is hosted by AVEVA in the Cloud.

Note: The License Server never connects directly to the Activation Server. Only the License Manager connects directly to the Activation Server. License activation is to a cloud-based server in all topologies.

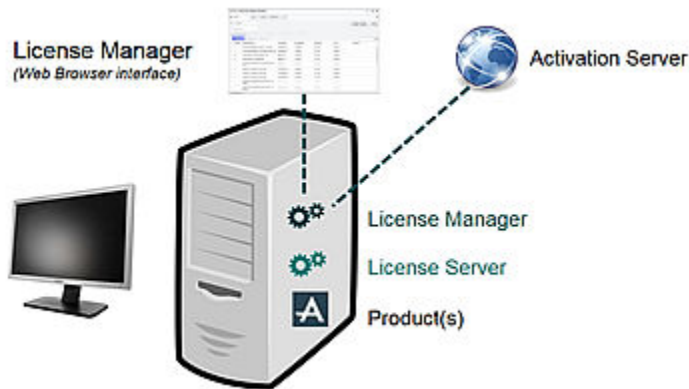

Advantages

Simple configuration for a small, single node system. Can easily be scaled to add more nodes.

Limitations

None for a small, single node system.

Multiple Nodes - Self-Hosted License Topology - Basic

This topology and the Multiple Node - Self-Hosted License Topology - Local License Managers (see [Multiple Nodes - Self-Hosted License Topology, Local License Managers](#) on page 30) are simple and work well in a small system of roughly five nodes, including InTouch tag-based architectures. As your system expands its total number of nodes, license management may be more efficient using one of the Multiple Nodes with Centralized Licensing topologies.

You can use the License Manager web browser interface to manage multiple nodes hosting separate License Servers. Each node could have its own License Server, License Manager with web browser interface, and could locally host its own license server.

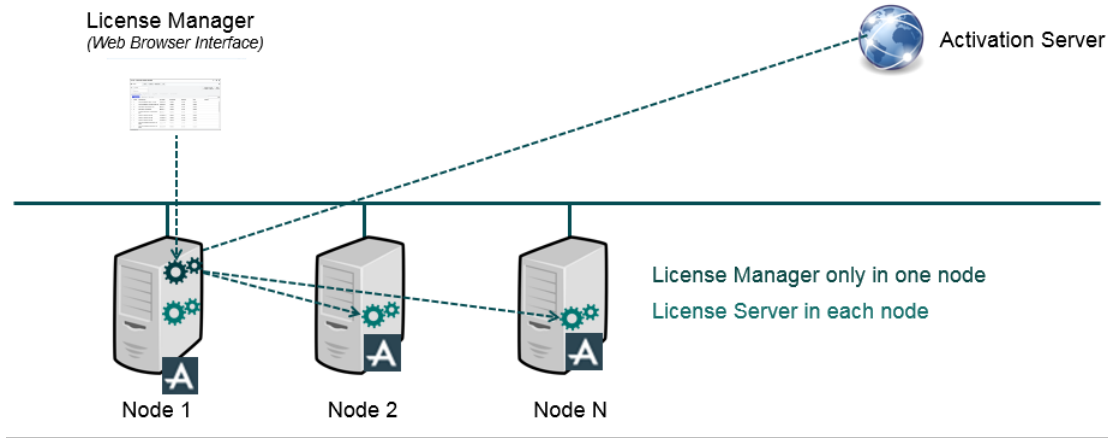

Advantages

A single License Manager can be used to connect to multiple License Servers.

Limitations

If the machine with the License Manager is damaged, License Manager must be installed in another machine.

Multiple Nodes - Self-Hosted License Topology, Local License Managers

The AVEVA Enterprise Licensing platform can enable each node to host its own License Server, License Manager, and the license(s) for the product(s) running at each node, and is commonly used in InTouch tag-based systems. This topology does not leverage the centralized management capabilities of the AVEVA Enterprise Licensing, and does not take advantage of License Server Redundancy features.

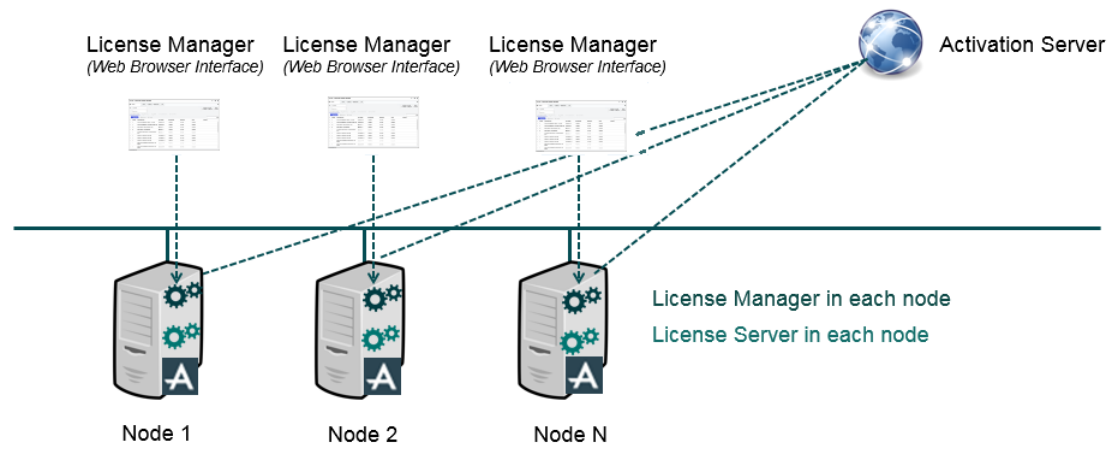

Advantages

In this configuration, a single License Manager can point to an individual License Server. Nodes can be segregated according to function or separate installed products.

Limitations

In addition to making limited use of the AVEVA Enterprise Licensing capabilities, this topology provides no centralized hosting of licenses. If a machine is damaged, its license goes with it.

Multiple Nodes - Centralized Licenses Topology

A License Manager can be installed on a machine separate from a License Server, and can connect to multiple License Servers. This type of topology provides more flexibility and convenience by allowing a single License Manager browser interface to manage multiple License Servers.

Note: License Server redundancy is always recommended for centralized license management.

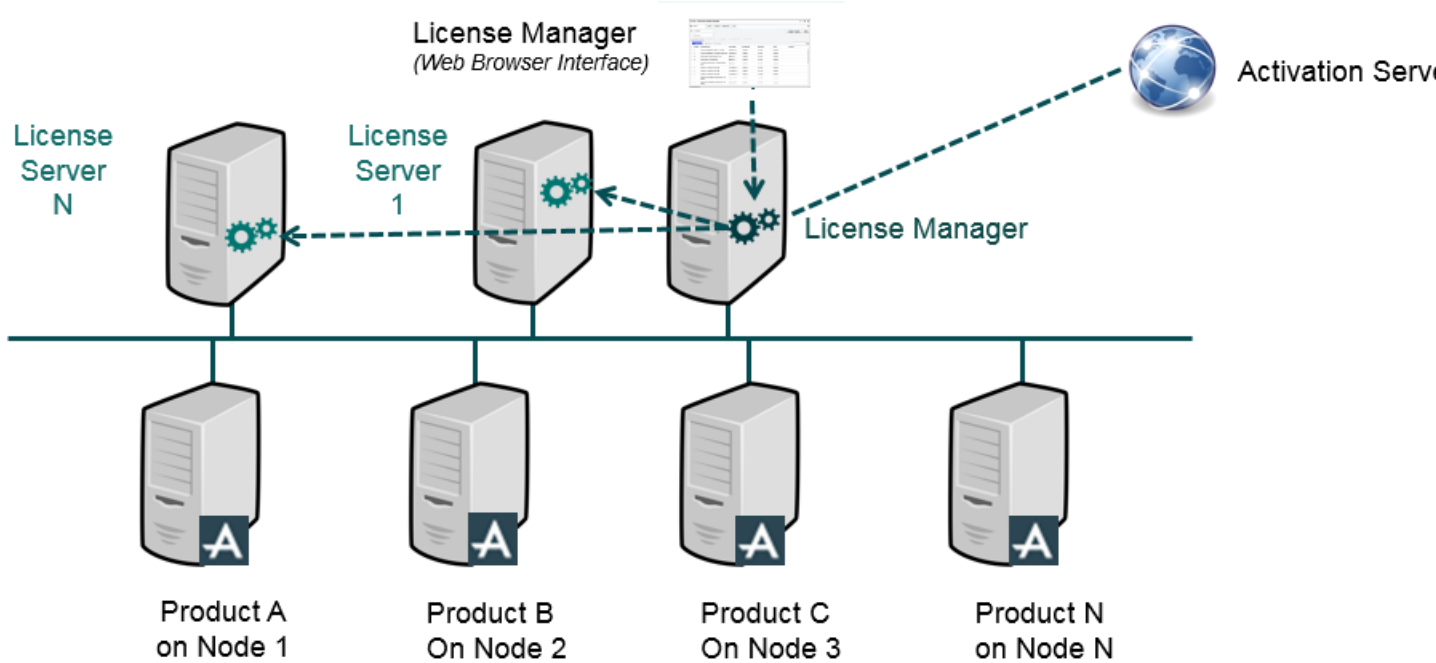

Advantages

The License Manager and the License Server can be installed on different machines.

Licenses can be centrally hosted and managed in a single License Server.

Limitations

If the single License Manager machine fails, License Server access and management is interrupted until a new License Manager is installed and configured, but no licenses, all hosted on individual License Servers, are compromised.

Dual Role Multiple Nodes - InTouch Tag-Based Centralized Licenses Topology

A topology featuring multiple nodes with centralized licenses can perform dual roles by hosting a Tag Server on the License Server node.

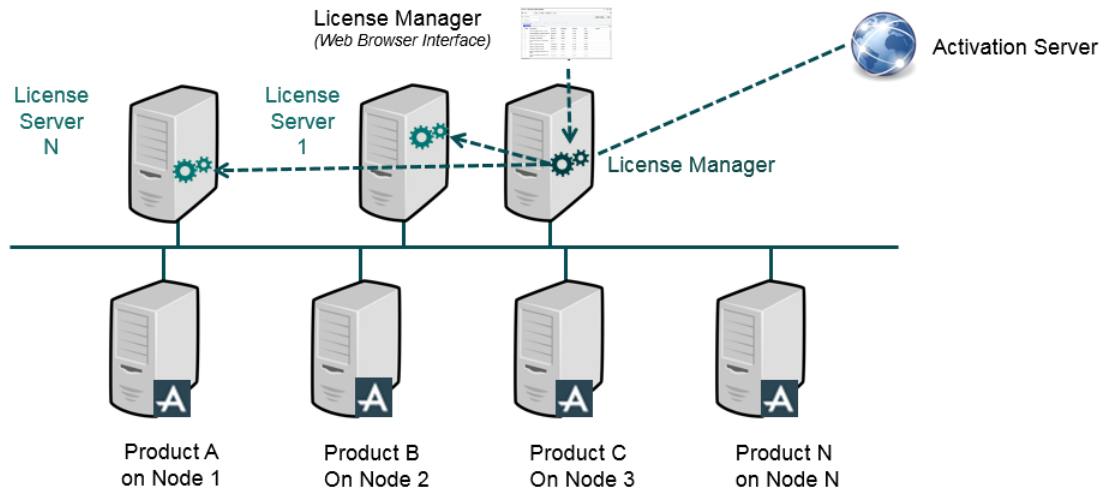

Advantages

Combining a License Manager, License Server, and Tag Server on the same node can provide greater convenience and manageability to an InTouch tag-based system.

Limitations

Adding a redundant server to the topology is highly recommended. A machine failure of the server node can result in both interruption of access to hosted licenses. License management would also be interrupted pending re-installing License Manager on a new machine.

Redundancy Topologies

License Server redundancy is highly recommended when centralizing your licenses. In all redundancy topologies, a paired set of License Servers keeps licenses, reservations and status of licenses synchronized. A synchronized copy of all licenses is kept on the backup License Server, as well as a synchronized list of acquired licenses and the nodes that acquired them.

If the primary License Server becomes unavailable, products can acquire their licenses from the backup server.

The License Manager user interface allows enabling redundancy, and specifying the name of a backup License Server node to create a pair. For information and procedures about implementing redundancy, see [Working With License Server Redundancy](#).

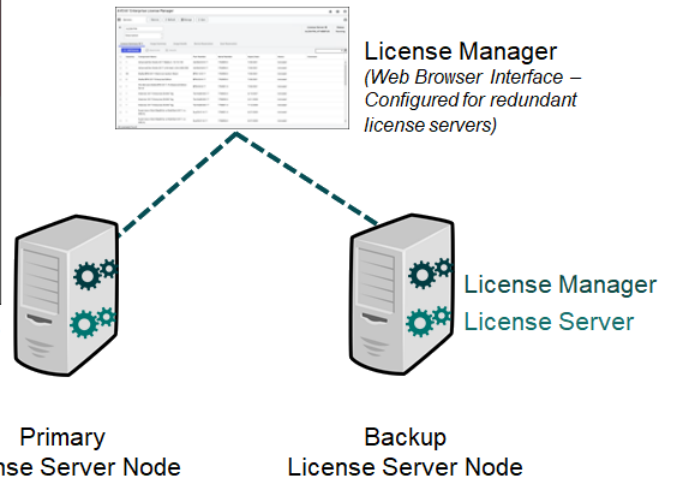
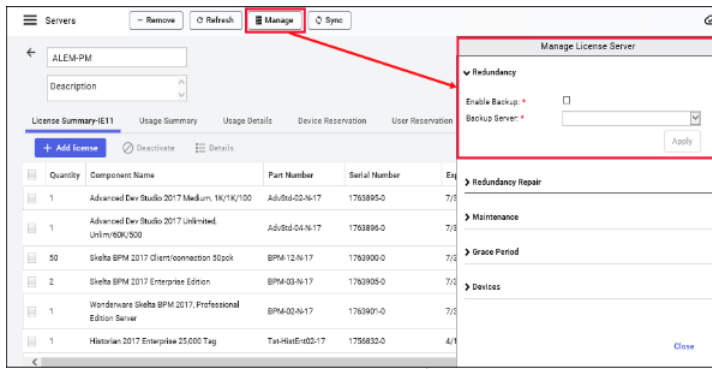

Important: You must configure the primary and backup License Server node names at each node that hosts the software products. This identifies the primary and backup servers in the redundant pair. For this reason, it is recommended that you set up your License Server pair before installing your software products.

Multiple Node InTouch Tag-Based Topology - Redundant License Servers

In an InTouch tag server-based architecture, a tag server node is a natural fit to also host a License Server.

If all licenses are identical, there is no need for reservations. If any license is different, reserve the license to guarantee a specific machine acquires the correct license.

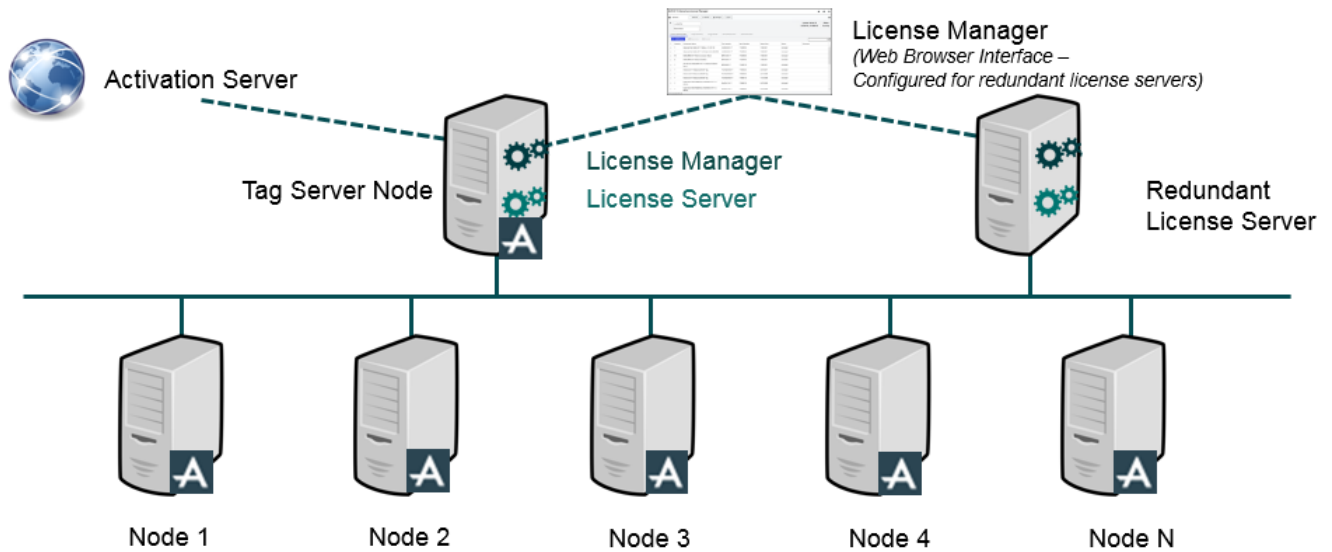

We recommend installing and configuring a redundant License Server, as described here, to safeguard your system and provide stable availability to your licenses.

Note: A best practice is to install a License Manager on the redundant License Server machine. If the primary machine fails, you can manage the licenses stored and synchronized on the redundant, backup, server.

Multiple Node InTouch Tag-Based Topology - Redundant License Servers and Tag Servers

In an InTouch tag server-based architecture, a tag server node and its backup are a natural fit to also host a License Server and its backup. In this topology model, two redundant InTouch tag servers have License Servers installed and configured as a redundant pair. Nodes with software products installed acquire their licenses from the primary License Server. In the event of a machine failure, licenses are acquired from the backup server.

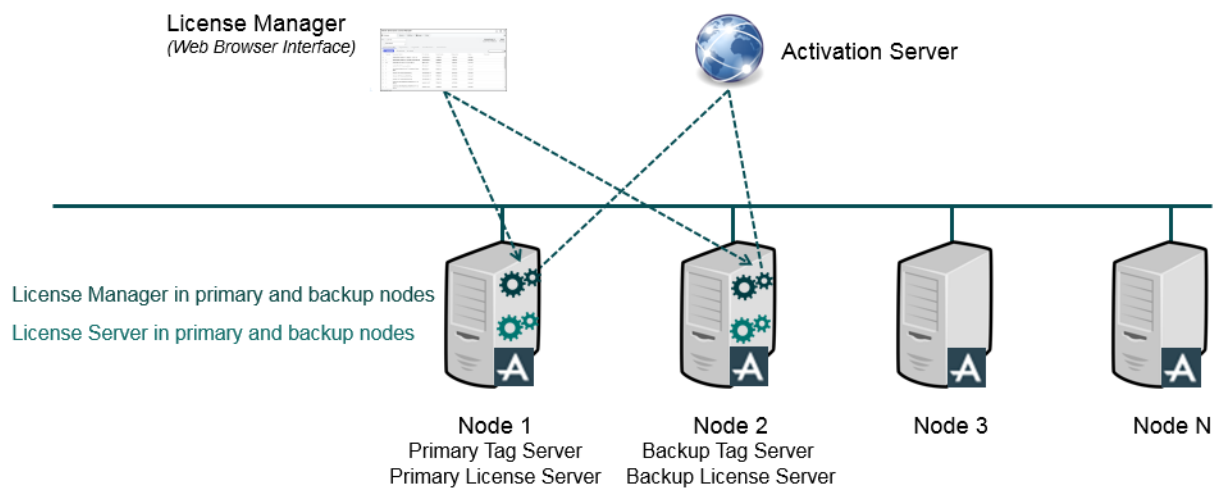

Advantages

Redundancy provides stable availability.

Capital expenditures can be mitigated by using two machines for dual purposes rather than purchasing separate License Server machines.

Limitations

None.

Redundant RDS Servers

The Remote Desktop Services (RDS) Windows component allows you to take control of a remote computer or virtual machine over a network connection. (RDS was known as Terminal Services in Windows Server 2008 and earlier.) A remote client machine that supports Remote Desktop Protocol (RDP) can access the Windows software and the entire desktop of the computer running RDS. This is sometimes known as a thin client.

In a redundant RDS servers model, you activate the primary client licenses in the primary RDS server and activate the failover client licenses (FLB) in the backup RDS server. A copy of these licenses is always synchronized and exists on the backup License Server. When failover occurs and the clients point to the backup License Server, the failover licenses will be available from the backup License Server.

Supervisory Client FLB Licenses are required for the backup RDS Server.

Note: You can use both ReadWrite and ReadOnly RDS licenses in the same License Server.

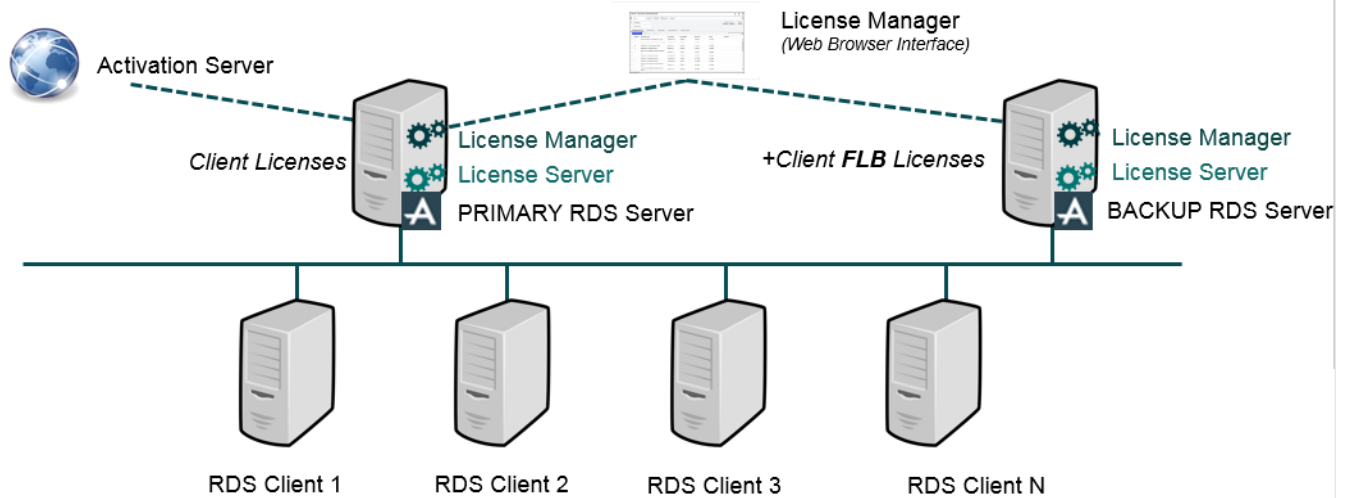

Advantages

RDS ReadOnly licenses can coexist with ReadWrite Licenses in the same License Server.

The redundancy in this model is provided by redundant RDS servers. To prevent overuse of licenses and potential unavailability at failover, there is no separate redundancy of License Servers.

Limitations

Licenses must be deactivated before cloning VMs, otherwise a Grace Period is triggered.

Redundant RDS Servers in a Virtualized Environment

Redundant RDS servers behave on virtual machines the same way they behave on physical machines. Refer to your VM software vendor's documentation to set up your virtual environment.

The same guidelines, advantages, and limitations apply to both hardware and virtual machines. For more information, see [Redundant RDS Servers](#).

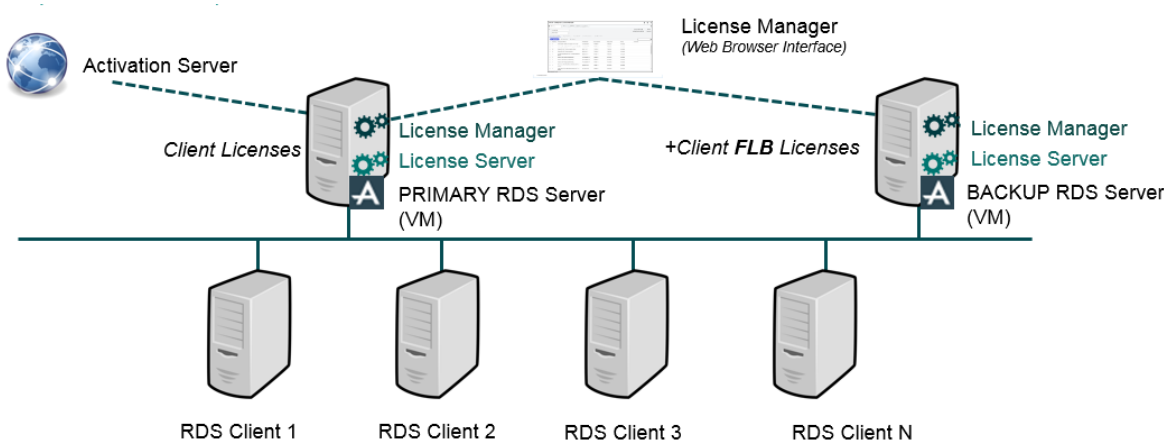

Redundant RDS Servers - Multiple Sessions from One Machine

In this topology model with three client machines, there would be nine primary licenses and nine failover licenses (FLB).

In this redundant RDS servers model, as with other redundant RDS server models, you activate both the primary client licenses and the failover client licenses (FLB) in the primary License Server. A copy of these licenses is always synchronized and exists on the backup License Server. When failover occurs and the clients point to the backup License Server, the failover licenses will be available from the backup License Server.

Supervisory Client FLB Licenses are required for the backup RDS Server.

Note: You can use both ReadWrite and ReadOnly RDS licenses in the same License Server.

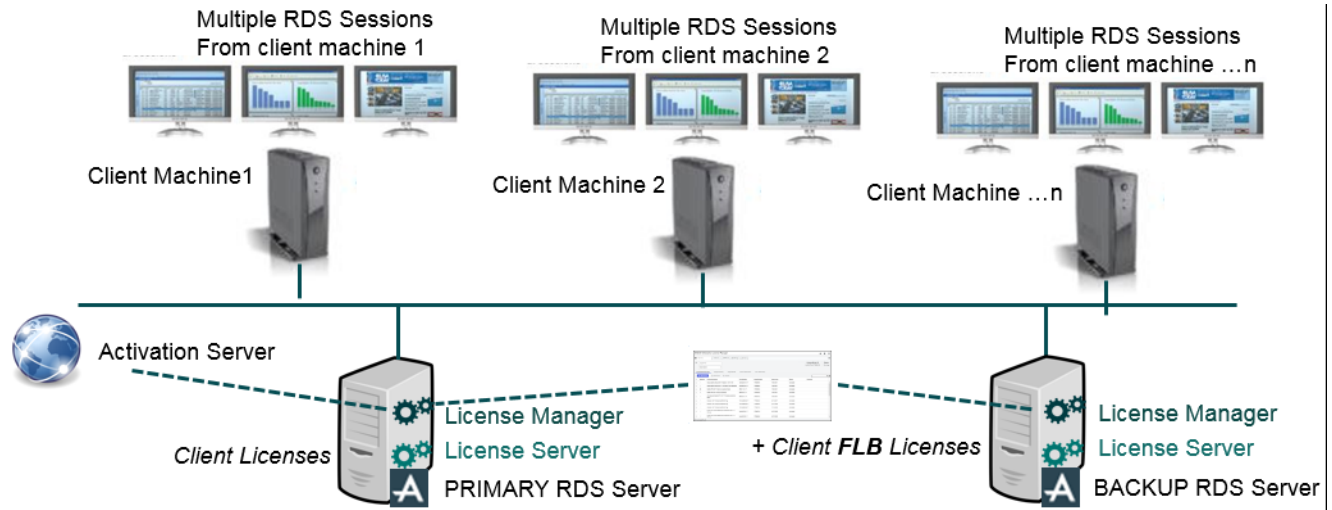

Advantages

Multiple RDS sessions can be run on each client machine, with licenses served from the License Server hosted on the primary RDS server, and managed by the License Manager hosted on the same RDS server.

RDS ReadOnly licenses can coexist with ReadWrite Licenses in the same License Server.

The redundancy in this model is provided by redundant RDS servers. To prevent overuse of licenses and potential unavailability at failover, there is no separate redundancy of License Servers.

Limitations

Licenses must be deactivated before cloning VMs, otherwise, a Grace Period is triggered.

High Availability and Disaster Recovery

This section provides details about high availability and disaster recovery topologies.

- [High Availability topology](#)
- [Disaster Recovery topology](#)

High Availability

High Availability (HA) refers to the availability of resources in a computer system following the failure or shutdown of one or more components of that system.

At one end of the spectrum, traditional HA has been achieved through custom-designed and redundant hardware. This solution produces High Availability, but has proven to be very expensive.

At the other end of the spectrum are software solutions designed to function with off-the-shelf hardware. This type of solution typically results in significant cost reduction, and has proven to survive single points of failure in the system.

About High Availability

High Availability refers to the availability of resources in a computer system following the failure or shutdown of one or more components of that system.

At one end of the spectrum, traditional HA has been achieved through custom-designed and redundant hardware. This solution produces High Availability, but has proven to be very expensive.

At the other end of the spectrum are software solutions designed to function with off-the-shelf hardware. This type of solution typically results in significant cost reduction, and has proven to survive single points of failure in the system.

High Availability topology

The following image shows the recommended topology for High Availability using Hyper-V technology.

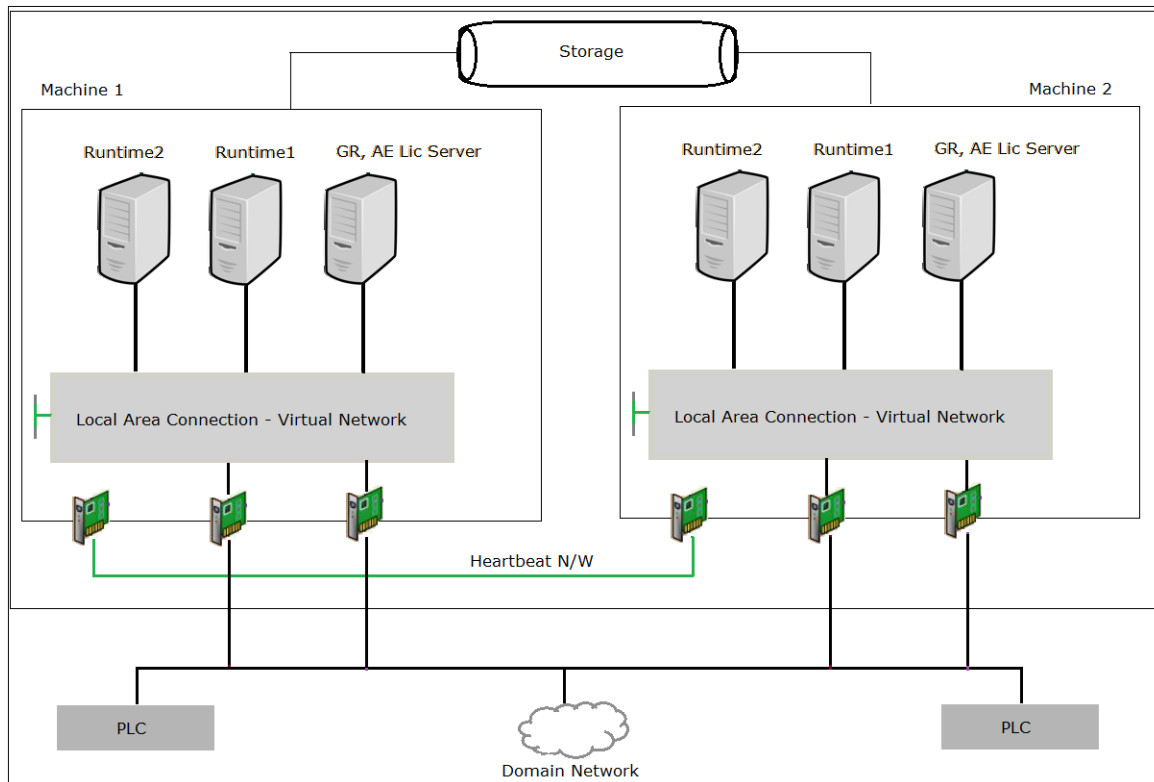

Disaster Recovery

Disaster Recovery (DR) planning typically involves policies, processes, and planning at the enterprise level, which is well outside the scope of this deployment guide.

Disaster Recovery, at its most basic, is all about data protection. The most common strategies for data protection include the following:

- Backups made to tape and sent off-site at regular intervals, typically daily.
- For the hardware and network failure scenarios, the virtual images restart following failover.

- For the hardware and network failure scenarios, the virtual images restart following failover.
- Backups made to disk on-site, automatically copied to an off-site disk, or made directly to an off-site disk.
- Replication of data to an off-site location, making use of storage area network (SAN) technology. This strategy eliminates the need to restore the data. Only the systems need to be restored or synced.
- High availability systems which replicate both data and system off-site. This strategy enables continuous access to systems and data.

About Disaster Recovery

Disaster Recovery(DR) planning typically involves policies, processes, and planning at the enterprise level, which is well outside the scope of this implementation guide.

DR, at its most basic, is all about data protection. The most common strategies for data protection include the following:

- Backups made to tape and sent off-site at regular intervals, typically daily.
- For the hardware and network failure scenarios, the virtual images restart following failover
- For the hardware and network failure scenarios, the virtual images restart following failover
- Backups made to disk on-site, automatically copied to an off-site disk, or made directly to an off-site disk.
- Replication of data to an off-site location, making use of storage area network (SAN) technology. This strategy eliminates the need to restore the data. Only the systems need to be restored or synced.
- High availability systems which replicate both data and system off-site. This strategy enables continuous access to systems and data.

The System Platform virtualized environment implements the fourth strategy—building DR on an HA implementation.

Disaster Recovery topology

The following image shows the recommended topology for Disaster Recovery using VMware vSphere technology.

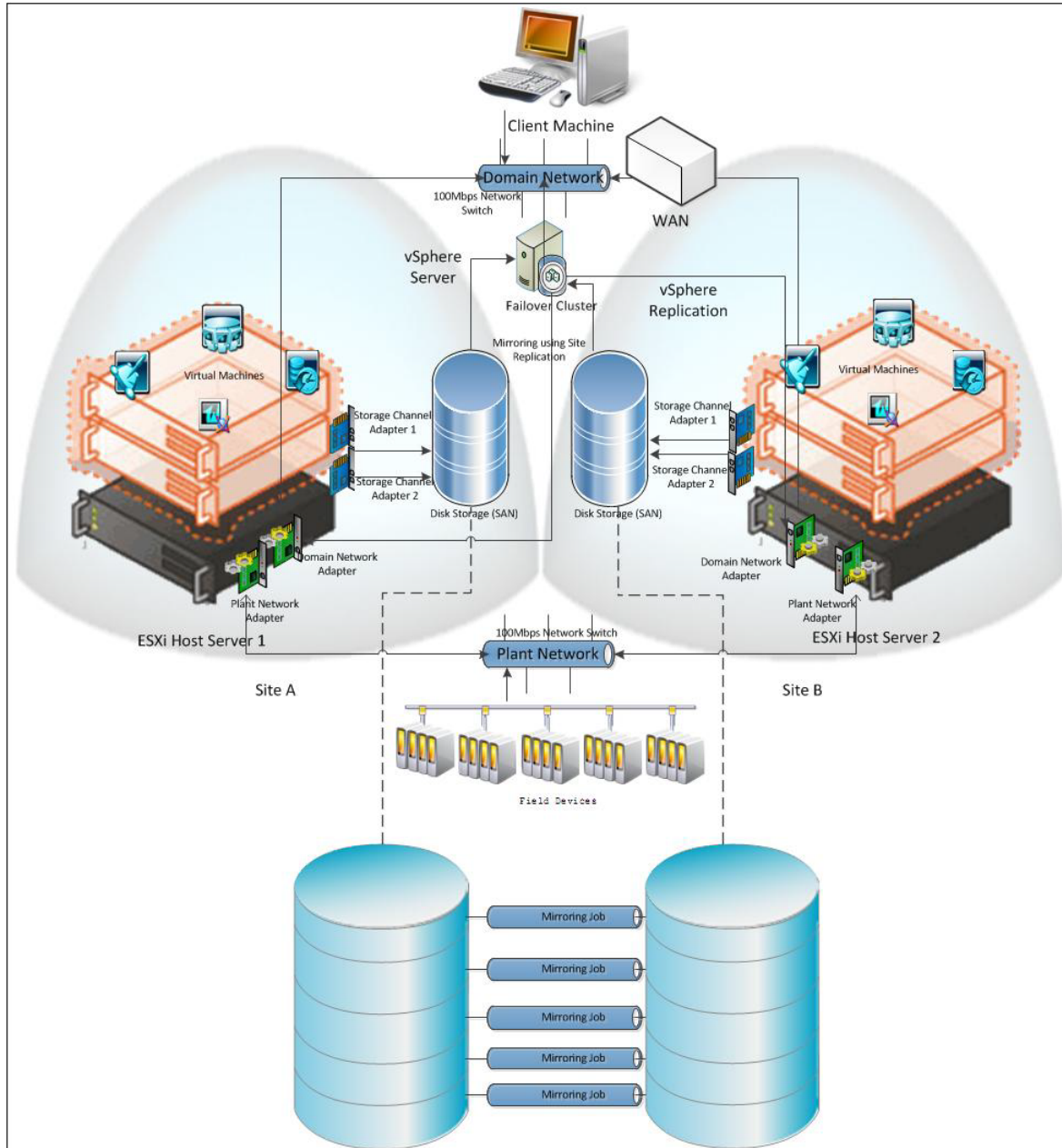

About High Availability and Disaster Recovery

The goal of a High Availability and Disaster Recovery (HADR) solution is to provide a means to shift data processing and retrieval to a standby system in the event of a primary system failure.

Typically, HA and DR are considered as individual architectures. HA and DR combined treat these concepts as a continuum. If your system is geographically distributed, for example, HA combined with DR can make it both highly available and quickly able to recover from a disaster.

AVEVA Enterprise Licensing Support for High Availability (HA) and Disaster Recovery (DR) in Virtual Environments

Virtual Environments: License Servers are supported in virtual environments. However, under certain circumstances, such as transferring a license from one virtual environment to another, the License Server may interpret the transfer as an improper move and therefore go into a grace period.

High Availability: License Servers in a High Availability virtual environment are supported in specific topologies. For more information about basic redundancy topologies, see [Redundancy Topologies](#).

Disaster Recovery: License Servers in a Disaster Recovery virtual environment will go into a grace period during DR activities. This is because DR activities are similar to an improper move of licenses and will trigger a grace period.

To avoid a grace period trigger in a DR virtual environment, we recommend that you run the License Server outside the virtualized DR environment and use a redundant License Server configuration through the functionality built into the License Server software. Another option is to purchase Disaster Recovery licenses at a discounted rate and establish a backup License Server with these additional licenses.

In all environments, we recommend you install and run the AVEVA System Monitor to monitor licensing functionality and view alerts on issues such as a License Server going into a grace period. When there is a notification of a Grace Period incident, contact AVEVA Technical Support to receive a "Grace Period Reset Code".

Note: While the License Server is in a grace period (15 days), all licenses continue to work without interruption.

Hyper-V Virtual Environment

High Availability (HA) in a Hyper-V virtual environment does not activate a licensing grace period during a failover as monitored environmental variables do not change.

Disaster Recovery (DR) in a Hyper-V virtual environment activates a licensing grace period as monitored environmental variables do change.

VMWare Virtual Environment

High Availability (HA) in a VMWare virtual environment does not activate a licensing grace period during a failover as monitored environmental variables do not change.

Disaster Recovery (DR) in a VMWare virtual environment activates a licensing grace period as monitored environmental variables do change.

Implement licensing components

The AVEVA Enterprise Licensing framework is very light weight and requires only a few steps to implement after you organize a topology to support your system requirements.

1. Install License Manager and License Server.
2. Work with the default settings or customize your basic setup by configuring the License Server for the product.
3. Access License Manager and Navigate through the License Manager.

Configure license server for the product

After completing the installation of your product, you need to define the location of the License Server that will host the licenses for the product.

To use the Configurator

A configuration tool is available at the end of the product installation process by clicking a **Configure** button.

Note: You can access the **Configurator** at any time post-installation to complete or modify your configuration by going to the Windows **Start** menu and clicking **Configurator**.

By default, the installation process identifies the local computer as the License Server name, and provides the default server port. Port 55559 and 59200 are the default ports for License server and can be configured.

Important: Before running the **Configurator**, make sure that the ports 55559 and 59200 are open.

To configure AVEVA Enterprise Licensing

1. Start the **Configurator**.
2. On the left navigation pane, expand **AVEVA Enterprise Licensing**, and select **Secure**.

The configuration screen appears.

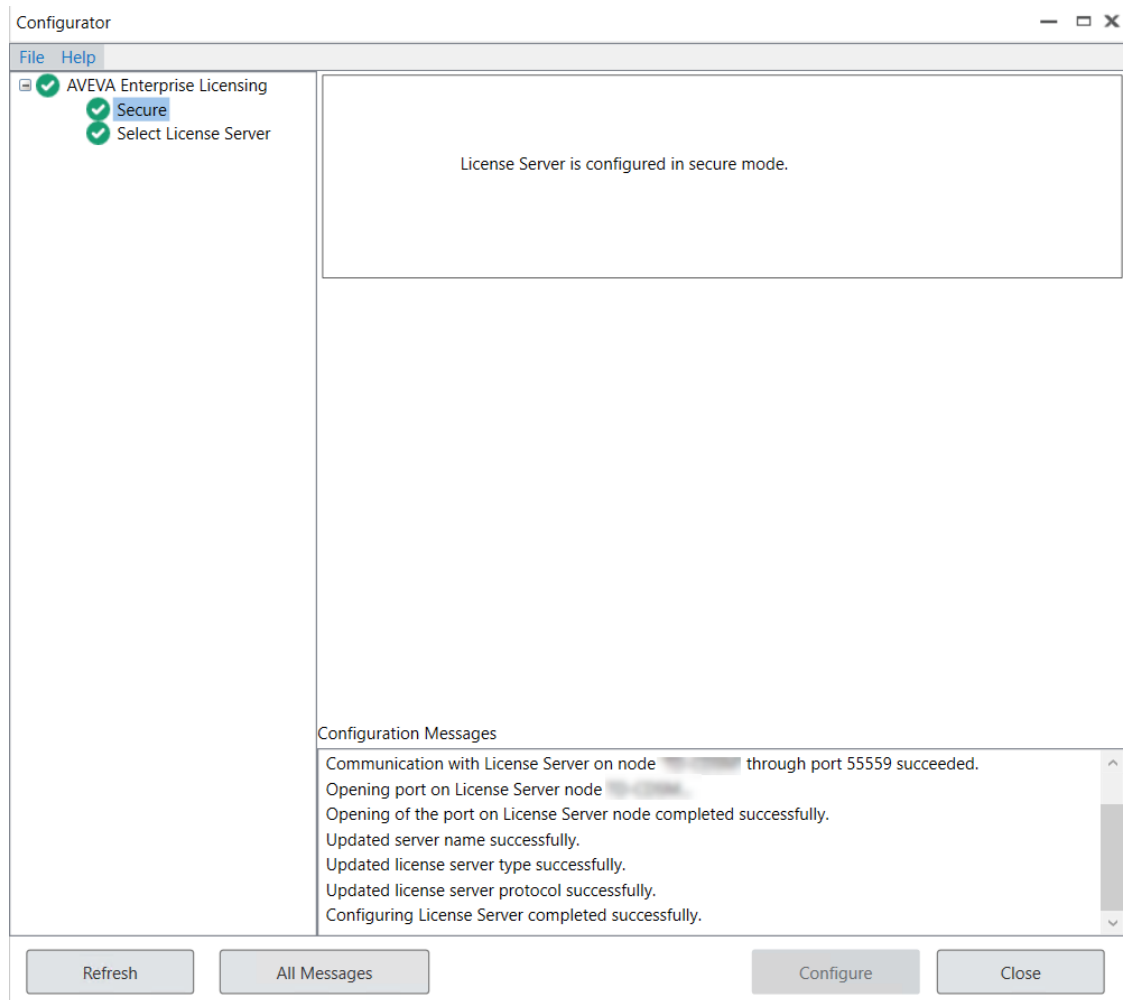

3. Click **Configure**.

License Server is successfully configured in secure mode.

4. In the left navigation pane, expand **AVEVA Enterprise Licensing** , and select **Select License Server**.

Then, in the right pane enter:

- **Primary Server Name:** if the License Server is not installed on the local node, enter the License Server name, or select a server name from the drop down list of previously-configured License Servers (if any).
Note: This is the IP address/machine name of the server that hosts the relevant licenses.
- **Server Port:** Enter the server port number. The default port number is 55559.
- **Agent Port:** Enter the license server agent port number. The default port number is 59200 (for WCF communication) or 59201 (for gRPC communication).
- **Legacy Server Port:** Enter the legacy license server port number. The default port number is 55555.

Note: Legacy Server Port configuration is required if License Server is prior to version 4.0.

5. Click **Test Connection** to verify the details are correct.

If the connection test succeeds, go to step 6.

If the test fails, messages indicating errors are highlighted in the **Configuration Messages** box. Verify your information and repeat the test.

6. Click **Configure**.

The license(s) are released from the host machine.

Note: You can configure the License server even when the specified primary server is unavailable.

For more information on configuring license server redundancy, refer to [Enabling License Server Redundancy](#)

About license manager security

Security requirements

The License Manager application can only be accessed by a user who is:

- An admin or a member of the AELicMgr security group on the local computer on which the License Manager is installed.
- An admin or a member of the AELicMgr group on the domain in which the License Manager computer resides.

The name of the logged-in user appears on the application window top bar.

Enabling browser logon

License Manager uses Windows authentication to securely validate logon permissions for users accessing the application. In order to enable the logon feature in your browser, refer to your browser documentation.

Working with Nodes in Workgroup Network Configuration

A workgroup network configuration can be implemented for smaller networks where it is not necessary to use an Active Directory domain controller to centralize network identification, roles and authorization.

In a workgroup network configuration, the credentials used to log in to a License Manager client node must be part of the AELicMgr or Administrator Security Identity groups configured on the License Manager Service node. If the account credentials are not part of either group, the License Manager Service will request new credentials that are part of the defined groups.

The basic process for how a local License Manager client node is either authenticated to access a remote License Manager Service node or requested for new credentials is described in the below diagram.

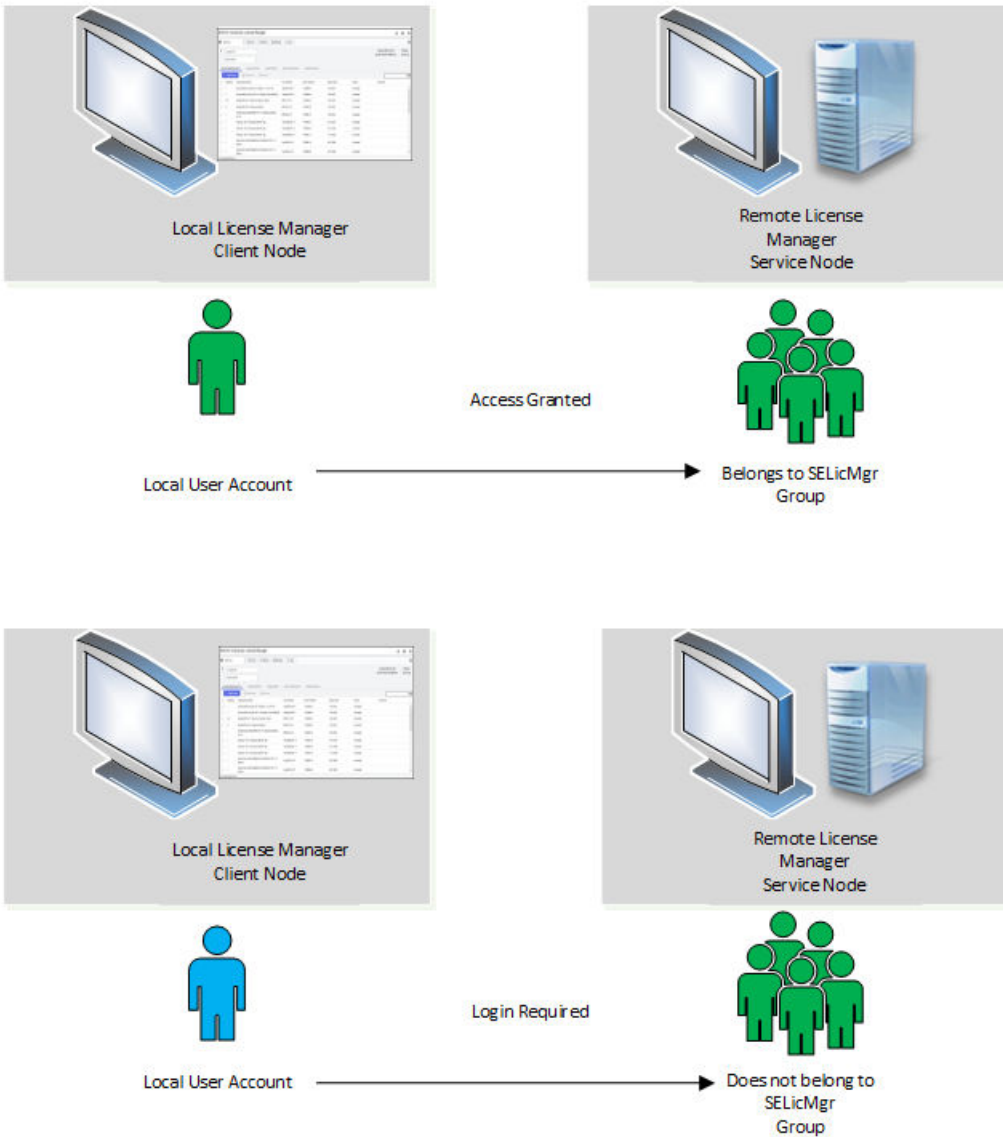

For additional security information and requirements, see [About license manager security](#).

Working with Back-end Applications in a Workgroup Environment

Back-end applications must access a local or remote License Server node to acquire licenses. When a workgroup topology is implemented and the License Server is installed on a remote node, special configuration arrangements are required.

The possible scenarios and applicable authentication processes are described below.

Scenario 1 (Recommended): License Manager, License Server and Installed Products on Single Node

Use of a workgroup configuration may not be as secure as an Active Directory domain controller. For security reasons, the recommended configuration is to have License Manager and License Server installed on each node that will have installed products that need to be licensed. Each node must belong to either the SELicMgr or Administrator Security Identity group.

Licenses should then be activated and administered only for the products installed on each node.

Scenario 2: Back-End or Clients Running on a Separate Node than the License Server

In this scenario, the License Server is installed on one node, and the products that need to acquire licenses are installed on another node and are running as User accounts. User accounts present their local identity to the remote node. The remote node will then examine the local user repository for the exact same user name and password from the requesting account.

If a match is found, the account that the back-end or client application is running as is authenticated. Otherwise it is not authenticated. This means that the account that the back-end or client application is running as must be replicated on the License Server node.

AE Workgroup Licensing Utility

AE Workgroup Licensing Utility configures licensing nodes that are in workgroup environment, so that node-to-node communication can be established between licensing components (License server and License Manger). The AE Workgroup Licensing Utility allows you to add a license server to a remote license manager in work group environment.

Using this utility, you have to create a new user account or use an existing user account. You must use the same user account on each node that requires communication with licensing components of other nodes in workgroup environment.

The AE Workgroup Licensing Utility is available under:

C:\Program Files (x86)\Common Files\ArchestrA\Licensing Framework\License Utilities

You can either run the AE Workgroup Licensing Utility in UI mode or in silent mode.

To run AE Workgroup Licensing Utility in UI mode

1. Right-click **SELicWorkgroup.exe** file, and select **Run as Administrator**.

The **AE Workgroup Licensing Utility** window appears.

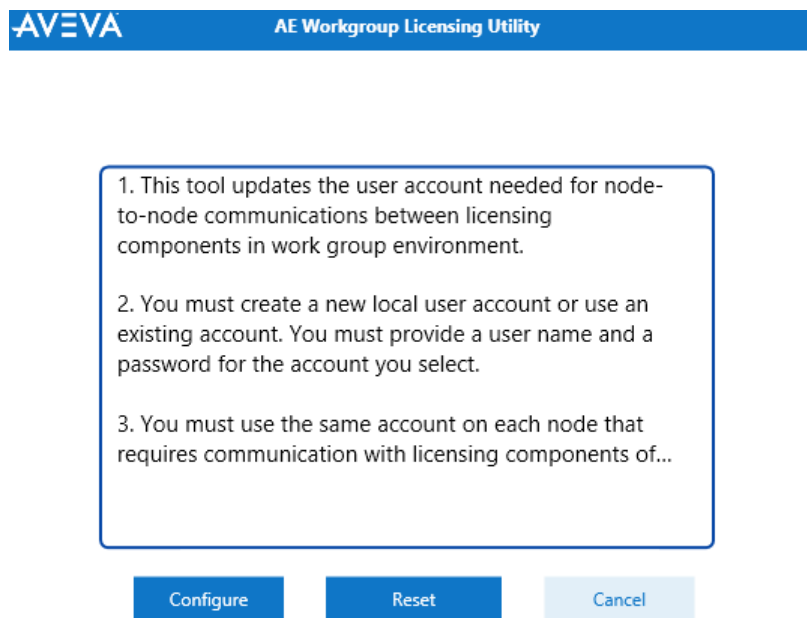

2. Read the instructions and click **Configure**.
3. In the **Create/Select User to configure** section, in the **User** field, enter a new user name or select an existing user from the dropdown list.
4. In the **Password** field, enter the password for the user account entered/selected.

Note: For a new user name, a **Confirm Password** field appears. Enter the same password.

5. Click **Configure**. A progress bar appears.
6. Once the workgroup is configured successfully, click **Finish**.

To run AE Workgroup Licensing Utility by silent mode

1. Run Command Prompt as Administrator.
2. To configure the Workgroup, use the following command:

```
"<SELicWorkgroup.exe file path>"/silent=true /username=<required user name for the SE Licensing> /password=<the corresponding password of the user>
```

where, "/silent" indicates silent execution.
3. Press **Enter**.
A message saying, "Workgroup configured successfully" appears.
4. To get help information, use one of the following command:

```
"SELicWorkgroup.exe file path" /?  
"SELicWorkgroup.exe file path" /h  
"SELicWorkgroup.exe file path" /H  
"SELicWorkgroup.exe file path" /Help
```

For example: "C:\Program Files\Common Files\Archestra\ Licensing Framework\Licensing Utilities\SELicWorkgroup.exe"/?

```

Administrator: C:\Windows\System32\cmd.exe
Microsoft Windows [Version 6.1.7601]
Copyright (c) 2009 Microsoft Corporation. All rights reserved.

C:\Windows\system32>cd C:\TeamProjects\Common Components\LicServer\LicServer-Dev
\src\Server\WorkgroupEnvironment\Debug\x86

C:\TeamProjects\Common Components\LicServer\LicServer-Dev\src\Server\WorkgroupEn
vironment\Debug\x86>SELicWorkgroup.exe /?

NAME:
    SE Licensing Workgroup Configuration Utility - Configures licensing nodes i
n workgroup environment.

USAGE:
    SELicWorkgroup /silent=true /username=<local user name for configuring SE L
icensing> /password=<password for the user>

SYNOPSIS:
    1. This tool updates the user account needed for node-to-node communications bet
ween licensing components in work group environment.
    2. You must create a new local user account or use an existing account. You must
provide a user name and a password for the account you select.
    3. You must use the same account on each node that requires communication with l
icensing components of other nodes in workgroup environment.

DESCRIPTION:
    SE Licensing Workgroup Configuration Utility configures licensing nodes in
workgroup environment. SE Licensing Workgroup Configuration utility requires at l
east local admin privilege within the local hosting process or remote session to
operate. This tool may only be used on a node in which Schneider-Electric Licens
e Manager or License Server has been installed. Informational, usage and diagnos
tic information shall be output to stdout and stderr appropriately and no input
shall be solicited from stdin.

OPTIONS:
    /silent      Designates silent execution.
    /h           /H           /help       Displays this help.
    /?

C:\TeamProjects\Common Components\LicServer\LicServer-Dev\src\Server\WorkgroupEn
vironment\Debug\x86>
    
```

To verify whether the node is configured or not

- Under **Computer Management**, in the **Users** folder, check for the new user that you have created.
- Under **Component Service**, in **Services(Local)**, check if the **License Manager** is logged on as the user that you have created/selected.
- Under **C:\ProgramData\Schneider Electric\Licensing\License Manager**, right-click **Data** folder and select **Properties**. Under **Security** tab, in **Group or user names** section, check if the user created by you is present.

You can use this tool to create the same user in all nodes. Once the nodes are configured, you will be able to add the license server in license server manager.

Chapter 3

Using AVEVA Enterprise Licensing

Accessing License Manager

License Manager is a browser-based application that manages your License Server(s).

You can access License Manager in several ways:

- You can open the Windows **Start** menu and search for Enterprise License Manager in the program search text box, then click the resulting browser link for Enterprise License Manager.
- You can access a License Manager installed on a local or remote node by opening your browser and going to the following URL:
`https://<nodename>/AELicenseManager`
where <nodename> is the name of the node, local or remote, where License Manager is installed.
- If you have configured License Server redundancy with a License Manager, you can manage the paired servers by accessing the License Manager on the primary node with the following URL:
`https://<primarynodename>/AELicenseManager`
where <primarynodename> is the name of the node where the primary license server is installed.
- If the primary node is unavailable, access the License Manager on the backup node by going to the following URL:
`https://<backupnodename>/AELicenseManager`
 - where <backupnodename> is the name of the node where the backup license server is installed.

For more information on changing default port numbers, see [Updating Ports on License Manager Nodes](#).

Important: If you configure your License Manager with a port number other than the default port 80, you need to include the port number in the browser URL to access License Manager. Use this URL: `http://<nodename>:<portnumber>/AELicenseManager`.

Navigating License Manager

License Manager has two primary work areas: the **License Server Summary Page**, and the **Details Page**. All License Manager functionality is available from one of these two pages.

Using License Manager, you can add or remove License Servers and you can start or stop the connected server. You can also pair two License Servers to enable server redundancy.

- Adding a License Server makes the License Manager the manager for that server.
- Removing a License Server disassociates it from the local License Manager, but does not uninstall the server from the computer where it is installed.
- Starting a License Server enables the services associated with managing the licenses hosted on that server.
- Stopping a License Server disables the services associated with managing the licenses hosted on that server.
- Pairing two License Servers in the same License Manager enables License Server redundancy. For more information see [Working With License Server Redundancy](#).
- License information is updated between the License Server and the Activation Server. For more information, see [Syncing Licenses](#).

It is recommended to manage multiple License Servers with a single License Manager. See the Deployment section for detailed information on the recommended topologies applicable to various environments.

Using the License Server Summary Page

Using the License Server Summary Page

The License Server Summary page provides information about the License Servers being managed by a given License Manager.

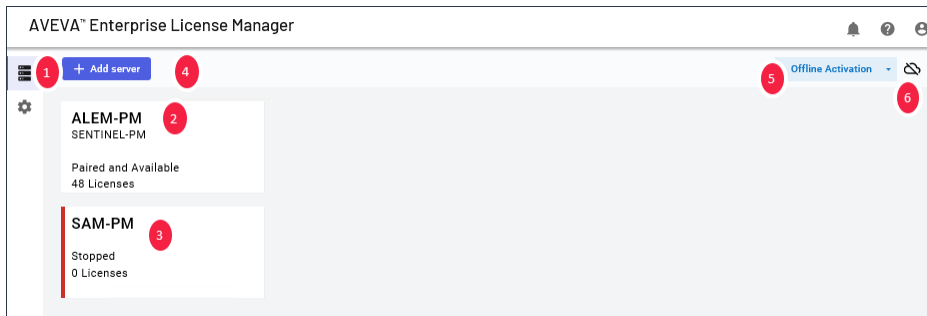

| Area | Description |
|------|-------------|
|------|-------------|

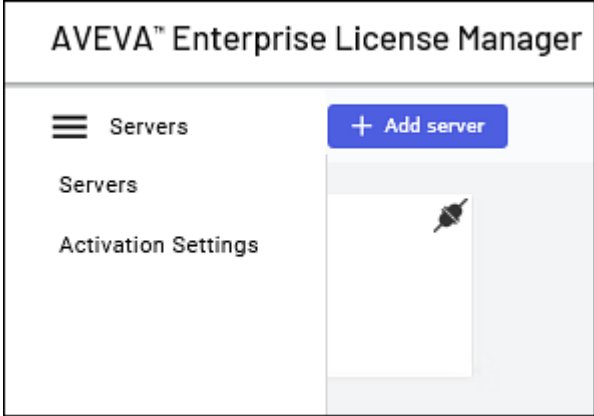
| | |
|---|--|
| 1 | <p>Click the Menu icon to open the Main Menu. The menu slides in from the left side, both on the Summary and Details Pages.</p>  |
| 2 | <p>Click the tile of a server to open that server on the Details Page.</p> <p>Each tile shows:</p> <ul style="list-style-type: none"> • The display name of the server • The display names of both servers if you configured a redundant pair • Whether the server is running or stopped • The availability status of the redundant pair, if configured • If configured, which server in the pair is unavailable • How many activated licenses the server currently hosts |
| 3 | <p>A stopped License Server's tile will appear with a red bar to the left of the tile.</p> <p>The icon in the upper right corner of the tile indicates the License Server is in connected state. This icon disappears if a License Server is paired.</p> <p>See Starting and Stopping a License Server for more information.</p> |
| 4 | <p>Click the Add Server icon to add a server to this License Manager.</p> <p>See Adding and Removing a License Server for more information.</p> |
| 5 | <p>The Offline Activation button shows activation mode and status.</p> |
| 6 | <p>The Cloud icon indicates whether License Manager has a connection with the Activation Server. The red "x" in this example indicates no connection. This is not a live status, but an indication of the configured Activation Settings.</p> |

Using the Details Page

Using the Details Page

The Details Page shows detailed information about the selected License Server (or both servers if a redundant pair is configured), its status and the specific licenses activated and in use hosted by the selected License Server.

The Details Page provides the tools you need to monitor license usage, to control the selected License Server, to set up license server redundancy, and to activate and deactivate licenses.

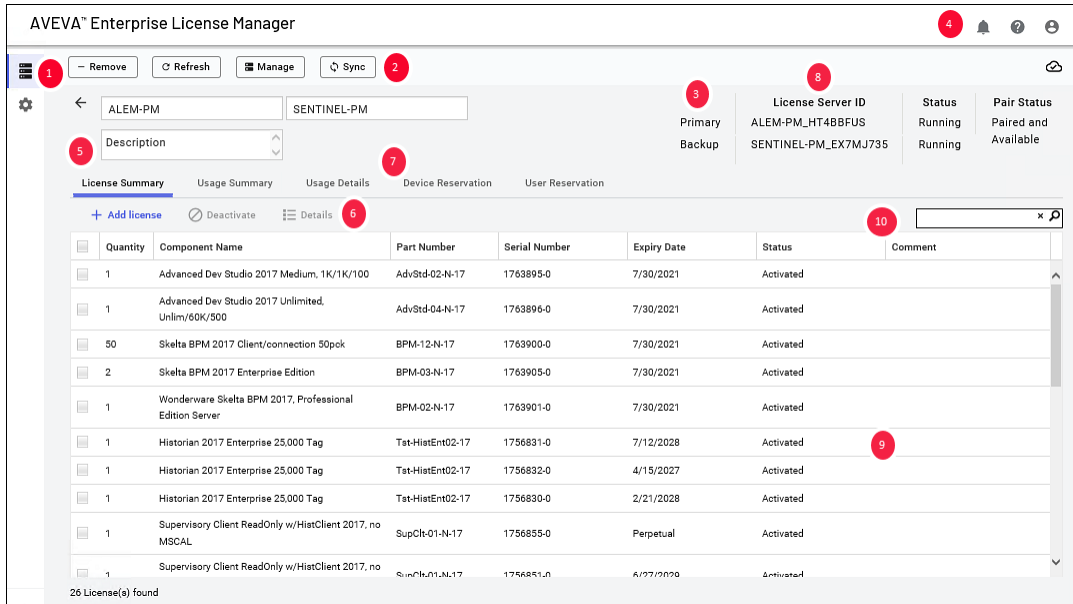

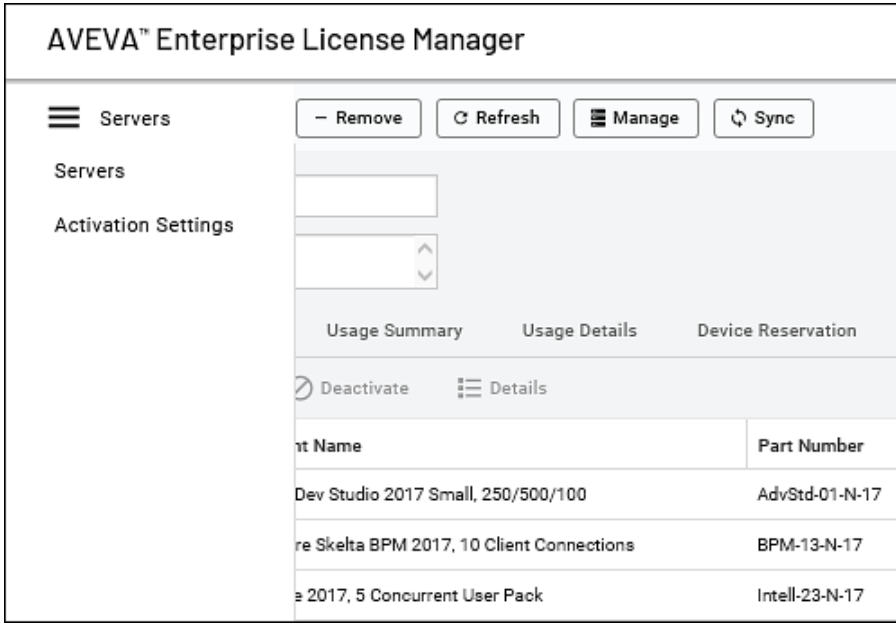
| Area | Description |
|------|--|
| 1 | <p>Click the Menu icon to open the Main Menu. The menu slides in from the left side, both on the Summary and Details Pages.</p>  |
| 2 | Action Bar: Contains available tools specific to the active License Manager page. |
| 3 | License Server display name and description (if any). If you configure a redundant pair, both server names are displayed here. |

| | |
|----|--|
| 4 | Logged-on user name and icon. Click icon to access License Manager help. |
| 5 | Back Arrow: Returns to the License Server Summary page. |
| 6 | <p>Add License, Deactivate, and Details buttons:</p> <ul style="list-style-type: none"> • Add License displays the License Activation pane. • Deactivate is enabled when one or more active licenses in the grid are selected. • Details is enabled when one active license in the grid is selected. |
| 7 | <p>Information grid tabs display the respective information grids.</p> <ul style="list-style-type: none"> • License Summary page • Usage Summary • Usage Details • Device Reservation • User Reservation |
| 8 | <p>License Server Detail information, including:</p> <ul style="list-style-type: none"> • The unique ID associated to the License Server. For a redundant pair, the unique IDs of both servers are displayed here. • The Status of the License Server. For a redundant pair, there is an additional Pair Status column. For details on status information, see Monitoring Pair Status Information. |
| 9 | <p>The License Summary grid, displays information about each activated license.</p> <ul style="list-style-type: none"> • Component Name • Part Number • Serial Number • Expiry Date • Status • Comment: An optional comment can be added for each license. <p>You can control the grid display by using the Rows Per Page and Page Number controls in the grid footer row.</p> |
| 10 | Grid filter: Enter search text to filter active licenses on any grid display. |

Viewing Details for a Specific License

To view details for a specific license

1. On the License Details page, select a license in the **License Summary** grid.
2. Click **Details** above the **License Summary** grid. The **License Details** pane appears.

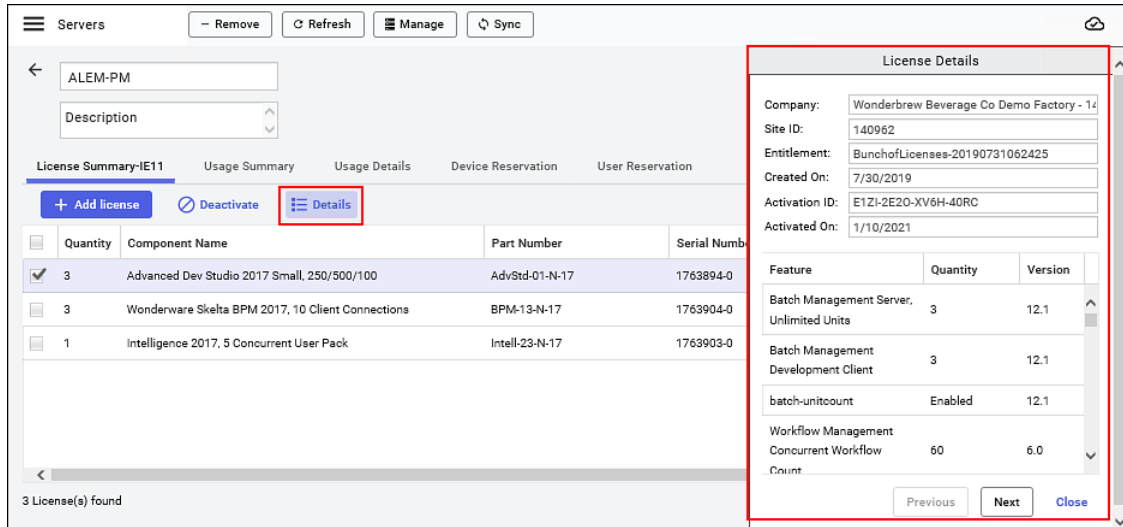

The **License Details** pane displays information about the selected license, including a License Activities log containing license creation, activation, and activation ID. The fields in the License Details pane are not editable.

Note: Click **Next** or **Previous** to view details for other activated licenses. Alternatively, you can click on any activated license in the License Summary grid to view license details.

1. Click **Close** to hide the **License Details** pane.

Using the Grid Filter

Use the grid filter to focus the displayed licenses according to your specific search terms.

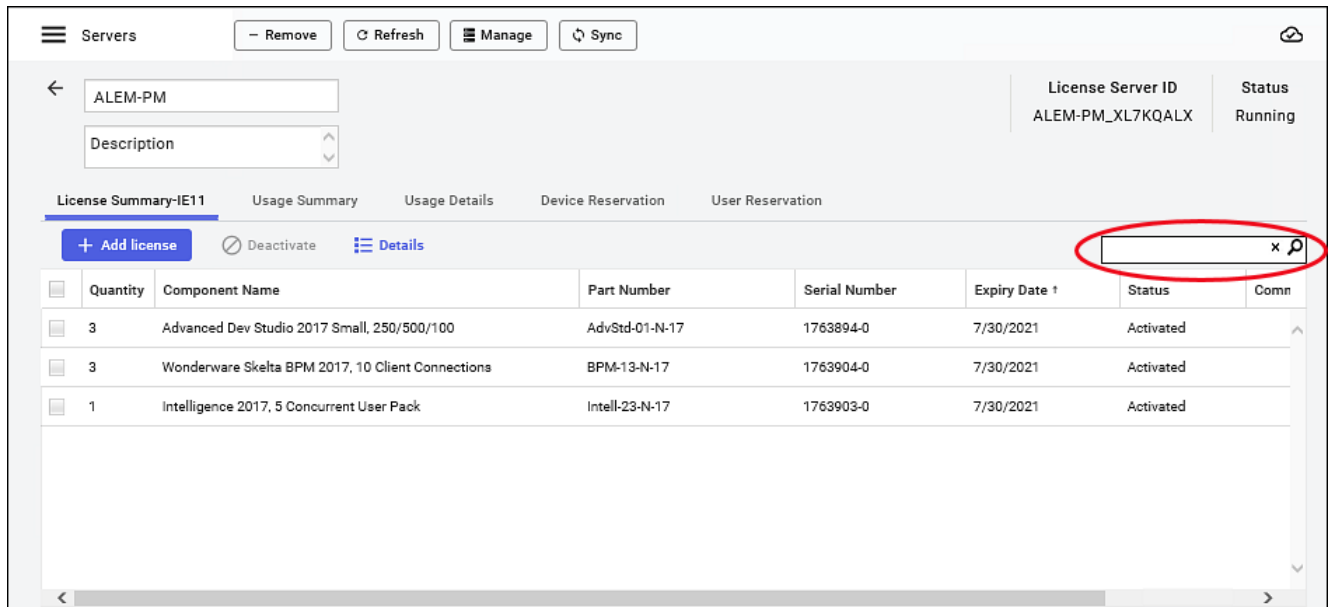

The grid filter is available on all grid displays:

- Details page
- Usage Summary tab

- Usage Details tab
- Device Reservation tab
- User Reservation tab

You can filter on a term in any grid column, across all grid pages.

Examples:

- Enter a user name in the **User Reservation** grid to display all licenses reserved for the named user.
- Enter a device name in the **Device Reservation** grid to display all licenses reserved for the named device.
- Enter a date to display all licenses that expire on that date.
- Enter a product name to display all licenses associated with the named product.

Activating and Acquiring Licenses

License Activation is the process of enabling a purchased license on a license server for use by a product. The activation server takes an Activation ID, validates it, and provides an activated license in return.

A license is created and delivered as an XML file (Entitlement File). The XML file contains one to many Activation IDs, one ID for each license purchased. You can activate the XML file by connecting the local License Server to the Activation Server in the Cloud by using the License Manager application installed on their local License Server.

Acquiring a license occurs when an installed product is started. An installed product, when running, acquires its activated license from the License Server and releases it when no longer needed. Once a license is acquired by a product software, the license cannot be used by another product until the license is released back to the License Server. The release of the license occurs when the product goes through a proper shutdown.

About Activation and Activation Modes

After you import your license [entitlement file](#) (), select the activation mode that best suits your topology. There are two modes available to process the license activation: online mode and offline mode. The activation mode you can use in a particular system depends on the connectivity of the License Manager components to the License Server and Activation Server.

- Use online activation when the License Manager node has network connectivity to the License Server AND Internet connectivity to the Activation Server.
- Use offline activation when the License Manager node has network connectivity to the License Server but does NOT have Internet connectivity to the Activation Server. In this case, a second node with Internet access to the Activation Server is required to complete the activation process using the License Activation Web Page.

Note: Optionally, you can use another installed License Manager in place of the License Activation Web Page. See [Activating Licenses in Offline Mode Using Two License Managers](#) for details.

The following diagram illustrates a topology in which you would use offline mode. In this topology, the License Manager is installed on Node 1, which has network connectivity to the License Server. Node 2 has Internet connectivity to the Activation Server and the License Activation Web Page. In this diagram, you can see the four basic steps for offline activation.

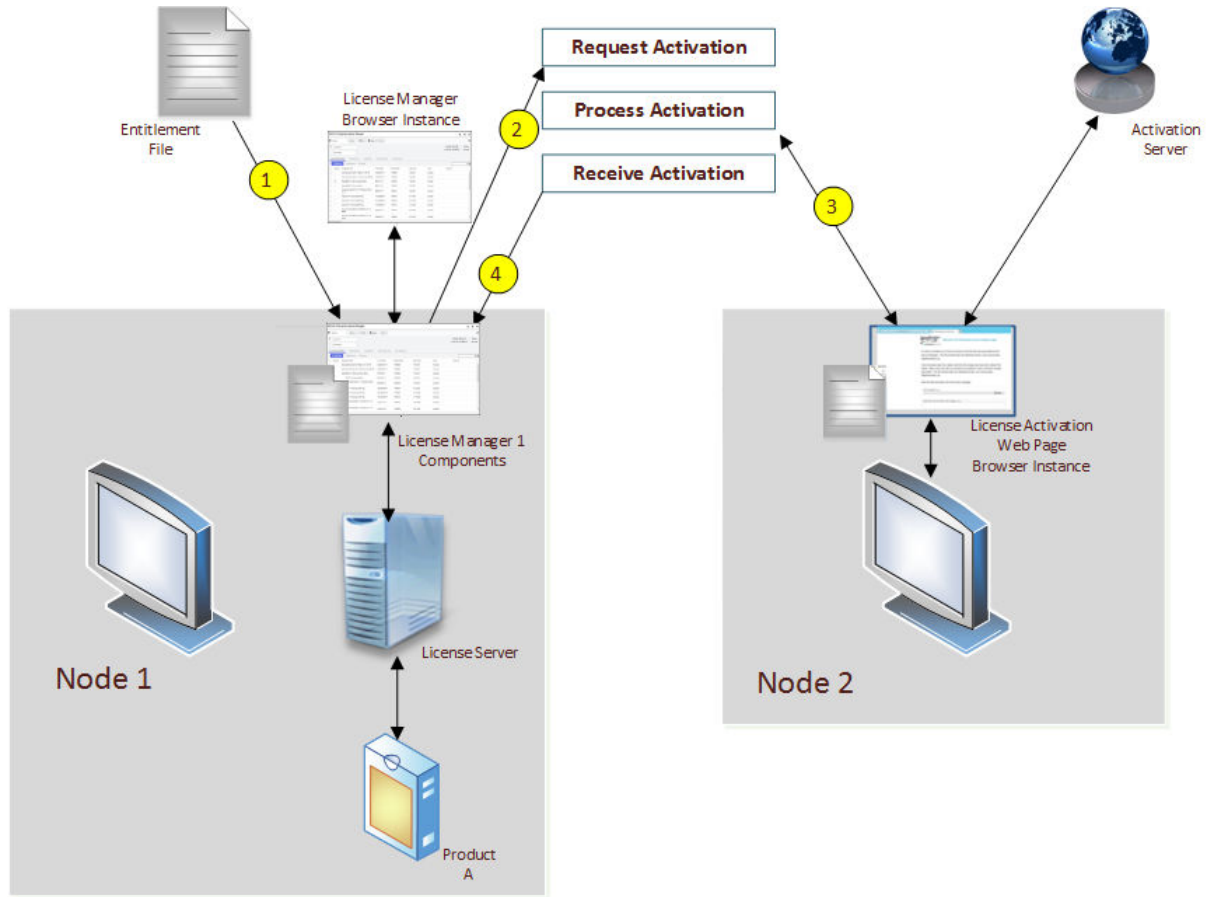

For both online and offline modes, use the License Manager or a second node with the licensing components installed to import an entitlement file and activate the licenses it contains.

During activation, the licenses in the entitlement file will be associated with the License Server and will become available to products that can access the License Server.

Setting the Activation Mode

The activation mode you select depends on the network topology where the license components are deployed. For more information, see [About Activation and Activation Modes](#).

Online activation is selected by default. Icons in the Action bar reflect the activation mode currently in use.

You can't change the activation mode if offline activation has been previously selected and activation or deactivation is pending. Once the offline activation or deactivation is complete you can then change the mode.

To set the activation mode

1. Open License Manager and click the **Menu** icon.

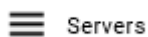

The **Menu** appears from the left side. Click **Activation Settings**. The **Activation Settings** dialog appears.

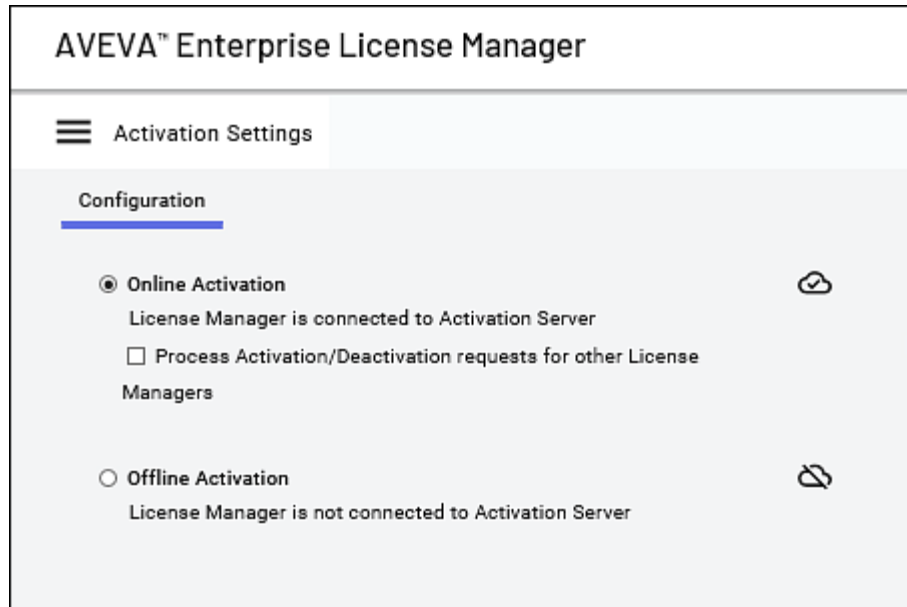

2. Select either **Online Activation** or **Offline Activation**.
3. For online activation, select **Process Activation/Deactivation requests from other License Managers** only if the node where the License Manager components are installed has Internet access to the Activation Server and you want to use it to process activation requests for OTHER License Managers with no Internet access to the Activation Server.

If you select **Offline Activation** or **Process Activation/Deactivation requests from other License Managers**, the Offline Activation button appears in the Action bar. This button might appear yellow, indicating that offline activation or deactivation actions are pending.

Activating Licenses in Online Mode

Online activation provides a workflow to activate your licenses when a system has access to the Internet and it can reach the AVEVA Activation Server. Online Activation is the default mode. The License is locked to the License Server node when the activation process takes place. During this Activation process, the local License Server is typically connected to the Internet, however, after Activation is complete, connection of License Server to the Activation Server in the Cloud is no longer necessary.

For online activation to work, make sure that:

- You have access to the entitlement file provided.
- The License Manager components node has connectivity to both the License Server and to the Activation Server over the Internet.

To activate licenses in online mode

1. If you have more than one License Server connected to your License Manager, click the tile of the server that will host the license(s) you want to activate.
2. Click **Add License** in the grid area.



The **License Activation** panel appears.

The screenshot shows the 'License Activation' panel. At the top right, the 'License Server ID' is 'ALEM-PM_XL7KQALX'. Below this is a search bar containing 'All Entitlements' and a 'Remove' button. A table lists various licenses with columns for 'Quantity to Activate', 'Component Name', 'Part Number', 'Serial Number', 'Activation Code', 'Quantity Activated', and 'Total Quantity'. The table contains 15 rows of license data. At the bottom right of the panel are 'Close' and 'Activate' buttons.

| Quantity to Activate | Component Name | Part Number | Serial Number | Activation Code | Quantity Activated | Total Quantity |
|----------------------|---|----------------|---------------|---------------------|--------------------|----------------|
| 0 | Wonderware Skelta BPM 2017, 10 Client Connections | BPM-13-N-17 | 1763904-0 | R89K-H7NE-OCPH-YF9Y | 3 | 3 |
| 0 | Advanced Dev Studio 2017 Small, 250/500/100 | AdvStd-01-N-17 | 1763894-0 | E1ZI-2E2O-XV6H-40RC | 3 | 3 |
| 0 | Intelligence 2017, 5 Concurrent User Pack | Intell-23-N-17 | 1763903-0 | LIW3-9M2T-8XG9-NFGT | 1 | 1 |
| 0 | InTouch 2017 RT Read-only 60K Tags | IntRO-01-N-17 | 1763887-0 | 7GGY-7BHY-S1SE-Q7BF | 0 | 10 |
| 0 | System Platform 2017 Professional | WSP-02-N-17 | 1763898-0 | XYDG-A39H-5G54-9AEB | 0 | 1 |
| 0 | Historian Incremental tags 2017, 500 | Histo-10-N-17 | 1763889-0 | 25RV-7Y2W-RJ9H-Q8JQ | 0 | 1 |
| 0 | Advanced Dev Studio 2017 Medium, 1K/1K/100 | AdvStd-02-N-17 | 1763895-0 | 6HSM-INOV-GMW6-7ZMW | 0 | 1 |
| 0 | System Platform 2017 IO Increment 1,000 | WSP-12-N-17 | 1763899-0 | 9S91-37VY-S76Z-HRGP | 0 | 10 |
| 0 | Advanced Dev Studio 2017 Unlimited, Unlim/60K/500 | AdvStd-04-N-17 | 1763896-0 | HCJ6-KJIF-HQ60-B300 | 0 | 1 |
| 0 | Wonderware Skelta BPM 2017, Professional Edition Server | BPM-02-N-17 | 1763901-0 | S513-RQYI-8HN8-ONT7 | 0 | 1 |
| 0 | InTouch Runtime 2017 60K Tags No IO | IntRT-01-N-17 | 1763886-0 | 7LJZ-QQ3S-XJJH-IECT | 0 | 1 |
| 0 | Skelta BPM 2017 Client/connection 50pck | BPM-12-N-17 | 1763900-0 | B0D2-1720-4H6M-F6A9 | 0 | 1 |
| 0 | mRmPI-02-N-17 | mRmPI-02-N-17 | 1763892-0 | QR1U-XFA4-IIL8-NPKZ | 0 | 1 |
| 0 | System Platform 2017 Standard | WSP-01-N-17 | 1763897-0 | P4UJ-M1WU-G0ZZ-YF6Z | 0 | 1 |

3. In the **License Activation** panel, click **Browse license file** to browse to your entitlement file to import it.

If you have already imported entitlements, use the checkbox to select the entitlement that contains the licenses you want to activate.

Note: Under **Activated** column, if it displayed as **Yes**, hold down **CTRL** and click the respective check box to select the license. All entitlements are shown by default. You can narrow the view of entitlements by selecting the entitlement that contains the license you want to activate.

4. Under the selected entitlement, select the license(s) to activate.
5. Click **Activate**.

The **License Activation** panel closes, and the selected licenses will show "Activated" status in the **License Summary Grid**.

| <input type="checkbox"/> | Quantity | Component Name | Part Number | Serial Number | Expiry Date | Status | Comment |
|--------------------------|----------|---|------------------|---------------|-------------|-----------|---------|
| <input type="checkbox"/> | 1 | Advanced Dev Studio 2017 Medium, 1K/1K/100 | AdvStd-02-N-17 | 1763895-0 | 7/30/2021 | Activated | |
| <input type="checkbox"/> | 1 | Advanced Dev Studio 2017 Unlimited, Unlim/60K/500 | AdvStd-04-N-17 | 1763896-0 | 7/30/2021 | Activated | |
| <input type="checkbox"/> | 1 | Skelta BPM 2017 Client/connection 50pck | BPM-12-N-17 | 1763900-0 | 7/30/2021 | Activated | |
| <input type="checkbox"/> | 2 | Skelta BPM 2017 Enterprise Edition | BPM-03-N-17 | 1763905-0 | 7/30/2021 | Activated | |
| <input type="checkbox"/> | 1 | Wonderware Skelta BPM2017, Professional Edition Server | BPM-02-N-17 | 1763901-0 | 7/30/2021 | Activated | |
| <input type="checkbox"/> | 1 | Historian 2017 Enterprise 25,000 Tag | Tst-HistEnt02-17 | 1756832-0 | 4/15/2027 | Activated | |
| <input type="checkbox"/> | 1 | Historian 2017 Enterprise 25,000 Tag | Tst-HistEnt02-17 | 1756830-0 | 2/21/2028 | Activated | |
| <input type="checkbox"/> | 1 | Historian 2017 Enterprise 25,000 Tag | Tst-HistEnt02-17 | 1756831-0 | 7/12/2028 | Activated | |
| <input type="checkbox"/> | 1 | Supervisory Client ReadOnly w/HistClient 2017, no MSCAL | SupClt-01-N-17 | 1756851-0 | 6/27/2029 | Activated | |

The activated licenses can now be consumed by your installed products as needed.

Video Tutorial: Online Activation



Activating Licenses in Offline Mode

Offline activation provides a workflow to activate licenses when a system does not have access to the Internet and thus to the AVEVA Activation Server.

Before you begin, click the **Activation Settings** menu option and select Offline Activation:

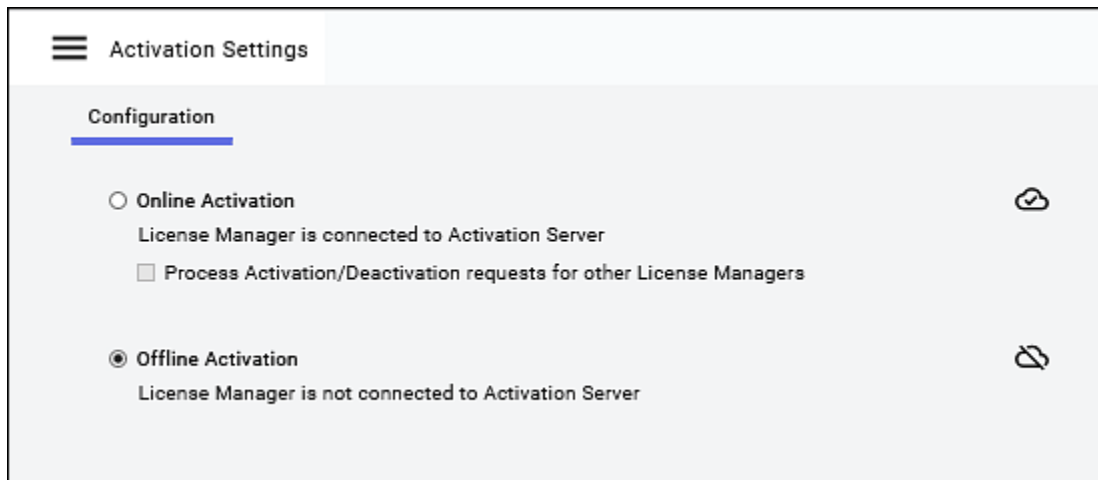

Note: Optionally, you can use a second License Manager with Internet connectivity to the Activation Server in place of the License Activation Web Page. See [Activating Licenses in Offline Mode Using Two License Managers](#) for details.

To activate a license in offline mode

1. Select the licenses to activate.
 - a. Open License Manager.
 - b. If you have more than one License Server connected to your License Manager, click the tile of the server that will host the license(s) you want to activate.

- c. Click **Add License** in the grid area.

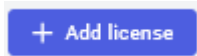

The **License Activation** panel appears.

License Activation License Serv
ALEM-PM_XL7

TestLicenses-20190222164804
Remo

| <input type="checkbox"/> | Quantity to Activate | Component Name | Part Number | Serial Number | Activation Code | Quantity Activated | Total Quantity |
|--------------------------|----------------------|---|----------------|---------------|---------------------|--------------------|----------------|
| <input type="checkbox"/> | 0 | Application Server 2017 5000 IO | WSPRT-02-N-17 | 1756829-0 | C5ZS-76SY-V2FD-R417 | 0 | 1 |
| <input type="checkbox"/> | 0 | DevStudio 2017 Limited, InTouch Dev/RT 64Tag | IntDev-01-N-17 | 1756835-0 | 5SKN-T1Z6-S07M-8PDU | 0 | 1 |
| <input type="checkbox"/> | 0 | Supervisory Client w/o HistClient 2017, no MSCAL | SupClt-02-N-17 | 1756850-0 | ZROQ-0IJ7-R4BO-ASMH | 0 | 1 |
| <input type="checkbox"/> | 0 | OI Servers Professional Edition G-2.0 | OISrv-03-N-17 | 1756840-0 | CTZZ-7LU7-BGRF-VDA1 | 0 | 1 |
| <input type="checkbox"/> | 0 | OI Servers Professional Edition G-2.0 | OISrv-03-N-17 | 1756839-0 | PXCB-FJLK-P0WN-IFQ7 | 0 | 1 |
| <input type="checkbox"/> | 0 | Supervisory Client w/o HistClient 2017, no MSCAL | SupClt-02-N-17 | 1756847-0 | UNAC-SCYG-NJLN-ZPXO | 0 | 1 |
| <input type="checkbox"/> | 0 | WW Historian Client/connection 2017 5 pack | Histo-21-N-17 | 1756844-0 | 8WFH-1SFA-YOTY-GGPO | 0 | 1 |
| <input type="checkbox"/> | 0 | DevStudio 2017 Limited, InTouch Dev/RT 64Tag | IntDev-01-N-17 | 1756837-0 | F6JO-4DE7-2W4M-DPK9 | 0 | 1 |
| <input type="checkbox"/> | 0 | Supervisory Client ReadOnly w/HistClient 2017, no MSCAL | SupClt-01-N-17 | 1756853-0 | UVAU-800Y-4FVI-R2VE | 0 | 1 |
| <input type="checkbox"/> | 0 | Supervisory Client w/o HistClient 2017, no MSCAL | SupClt-02-N-17 | 1756848-0 | YG8Q-K5CC-5CC5-GHLJ | 0 | 1 |
| <input type="checkbox"/> | 0 | Supervisory Client ReadOnly w/HistClient 2017, no MSCAL | SupClt-01-N-17 | 1756851-0 | KE5V-50N8-GGNP-30VT | 0 | 1 |
| <input type="checkbox"/> | 0 | Historian InSight 5 User-New Subscription | Histo-31-N-17 | 1756834-0 | 75ZO-1RIT-8AOJ-T7XG | 0 | 1 |
| <input type="checkbox"/> | 0 | WW Historian Client/connection 2017 5 pack | Histo-21-N-17 | 1756845-0 | 05YD-WNBS-WI0D-5B6Q | 0 | 1 |

[Close](#)

- d. In the **License Activation** panel, click **Browse license file** to browse to your entitlement file to import it.

If you have already imported entitlements, use the checkbox to select the licenses to activate.

Note: Under **Activated** column, if it displayed as **Yes**, press **ctrl + click** on the respective check box to select the license.

- e. Under the selected entitlement, use the checkbox to select the licenses to activate.
- f. Click **Activate**.

The **License Activation** panel closes, returning you to the Details page. The selected licenses will show **Pending Activation Request** status in the license grid, and **Offline Activation** in the Action Bar turns yellow.

Pending Activation Requests can be canceled until offline activation is requested. See [Canceling a Pending Offline Activation/Deactivation](#) for details.

2. Request offline activation.

- a. From the Server Details Page, click the yellow **Offline Activation** button. The **Offline Activation** dialog box opens.
- b. Click **Request Activation / Deactivation**. The activation request will create a file with a ".sync" file extension to send the activation request.

The file name can be changed, but not the file extension.

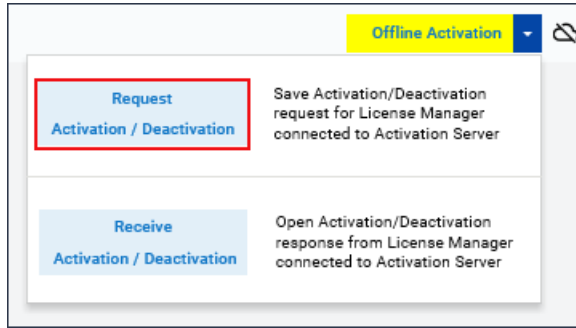

- c. Save the file to a convenient location where you can easily retrieve it from another computer on your network.

The selected licenses will now show **Pending Activation** in the **Status** column on the license grid.

Note: You can set up your browser to automatically save the file to a specific location. Refer to your browser settings documentation.

3. Process offline activation using the License Activation Web Page on the node with Internet connectivity.

Note: A second License Manager installed on a node with Internet connectivity can substitute for the Activation Web Page in this step. See [Activating Licenses in Offline Mode Using Two License Managers](#) for details.

- a. On the node with Internet connectivity, point your web browser to the [Global Customer Support](#) website.
- b. Select the **License Activation** tile from the **Knowledge & Support Center** options:

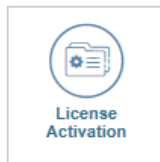

The **License Activation** Web Page appears.

- c. Browse to the .sync file created in step 2. b. and upload it in the **File to upload** field.
- d. Enter the text code and click **Upload File**.

The process request will create a file with a ".sync" file extension. The file name can be changed, but not the file extension.

- e. Save the file to a location where you can easily retrieve it from another computer on your network.
4. Receive offline activation on the License Manager node.
 - a. From the Server Details Page, click the yellow **Offline Activation** button. The **Offline Activation** dialog box opens.

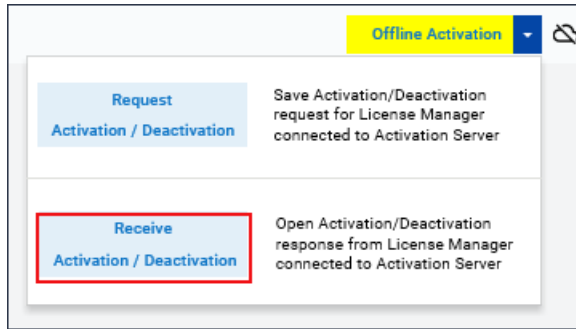

- b. Click **Receive Activation / Deactivation**. You will be prompted to locate the file. Navigate to the location where you saved the file. Select the file and click **Open**.

The selected license is shown as **Activated** in the License Summary grid. The activated licenses can now be consumed as needed by your installed products.

Video Tutorial: Offline Activation



Activating Licenses in Offline Mode Using Two License Managers

The procedure for activating licenses in offline mode using two License Managers is similar to activating licenses in offline mode using the License Activation Web Page. For this activation method, you need two License Managers:

- A License Manager with network connectivity to the License Server but no Internet connectivity to the Activation Server (License Manager #1 in the following procedure)
- A License Manager with Internet connectivity to the Activation Server (License Manager #2 in the following procedure)

Before you begin, configure the following settings for your two License Managers using the **Activation Settings** menu option:

- In the offline License Manager, select **Offline Activation**.

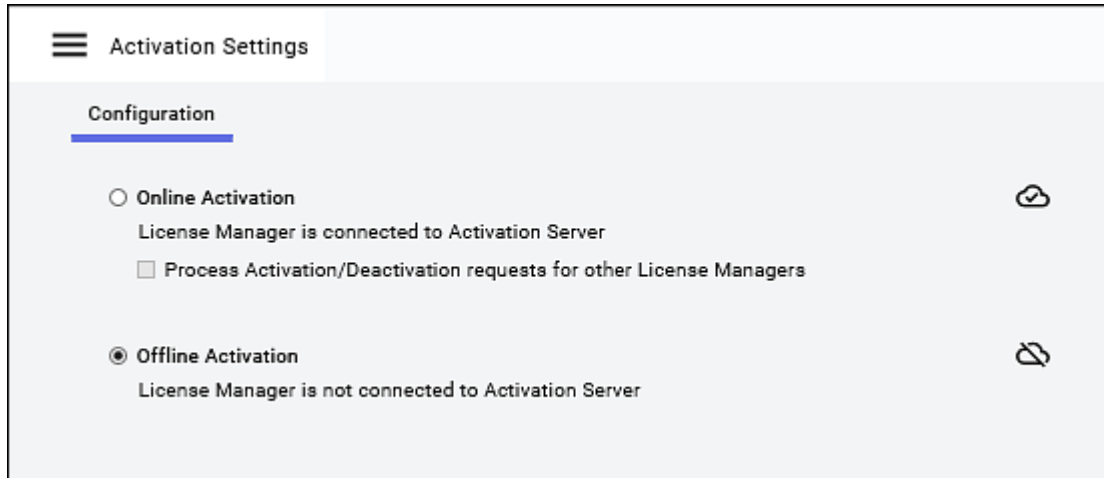

- In the online License Manager, leave the **Online Activation** option selected and also check the **Process Activation/Deactivation** requests from other License Managers option. The **Offline Activation** button appears in the Action Bar.

To activate a license in offline mode

1. In License Manager #1, generate and save your activation request file.
See [Activating Licenses in Offline Mode](#) for the detailed procedure.
2. Process offline activation using License Manager #2.
 - a. Click the yellow **Offline Activation** button and select **Process Activation/Deactivation**.
You will be prompted to locate the file generated in Step 1.
 - b. Select the file and click **Open**.
Save the activation response file.
3. Receive offline activation in License Manager #2.
 - a. Click the yellow **Offline Activation** button and select **Receive Activation/Deactivation**.
You will be prompted to locate the file generated in Step 2.
 - b. Select the file and click **Open**.
Your license will now be shown as **Activated** in the license grid.

Activating Licenses by Splitting Between Multiple License Servers

The AVEVA Enterprise License Manager version 3.6 onwards supports activating licenses by splitting the available number of licenses between multiple license servers. With this functionality, you can split a set of licenses included in a single Activation ID between multiple license servers for activation. You need not activate all the licenses on the same License Server.

Example 1:

Consider an Activation ID of twenty licenses of ‘InTouch RT 1000 Tags’. You can split the twenty licenses between multiple License Servers, say License Server A, License Server B, and License Server C, for activation. You can activate five licenses of ‘InTouch RT 1000 Tags’ on License Server A, ten licenses of ‘InTouch RT 1000 Tags’ on License Server B; and five licenses of ‘InTouch RT 1000 Tags’ on License Server C; any combination that totals to

twenty is possible. However, each InTouch RT 1000 Tags license must remain as a unit, so you cannot split the 1000 Tags across multiple License Servers.

Example 2:

Consider an Activation ID of five licenses of 'Hist Client 20 Pack'. You can split the five licenses between two License Servers, say License Server A and License Server B, for activation. You can activate three licenses of 'Hist Client 20 Pack' on License Server A and two licenses of 'Hist Client 20 Pack' on License Server B; or, four licenses on License Server A and one license on License Server B, any combination that totals to five is possible. However, each Historian Client 20 Pack license must remain as a unit, so you cannot split the 20 pack of concurrent counts across multiple License Servers.

Deactivating Licenses in Online Mode

If you want to remove an activated license from a License Server you need to deactivate it first. Online deactivation applies to the same topologies as [Activating Licenses in Online Mode](#).

To deactivate a license in online mode

1. Select the license(s) you want to deactivate in the license grid.
Select a single row, or use the check boxes to select multiple rows. The **Deactivate** button is enabled.
2. Click **Deactivate**.
The selected licenses are removed from the grid and are no longer available for the products to use. You can activate these licenses on the same server or a different server at a later time.

Deactivating Licenses in Offline Mode

Offline deactivation follows the same basic workflow and applies to the same topologies as [Activating Licenses in Offline Mode](#).

The workflow described here is based on two nodes: one with License Manager installed and network connectivity to the License Server, and one with Internet connectivity.

Note: The procedure for deactivating licenses in offline mode using two License Managers is similar to the procedure described below. License Manager #2 would substitute for the License Activation Web Page.

To deactivate a license in offline mode

1. Select the license(s) you want to deactivate in the license grid.
The **Deactivate** button becomes enabled. Click **Deactivate**.
The selected license status changes to **Pending Deactivation Request**. The **Offline Activation** button turns yellow to indicate pending requests.
You can cancel pending activation or pending activation request at this point by clicking **Cancel Pending Actions**. For more information, see [Canceling a Pending Offline Activation/Deactivation](#).
2. Request offline deactivation from the License Manager node.
 - a. From License Manager, click the yellow **Offline Activation** button. The **Offline Activation** dialog box opens.
 - b. Click **Request Activation / Deactivation**. The deactivation request will create a file with a ".sync" file extension to send the deactivation request.

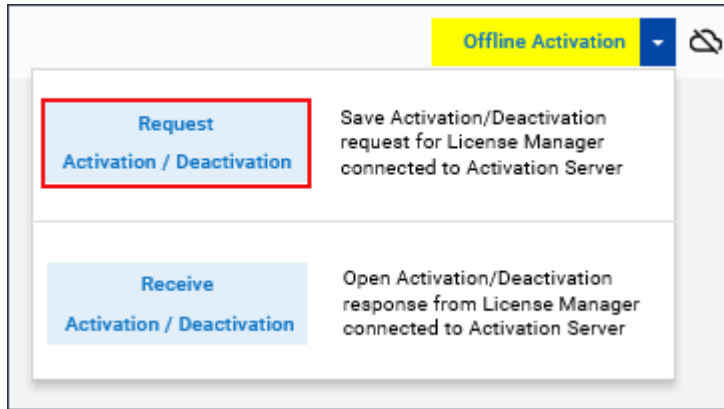

- a. Save the file to a convenient location where you can easily retrieve it from the node with Internet connectivity.

The selected licenses will now show **Pending Deactivation** in the license grid.

- 3. Process offline deactivation using the License Activation Web Page.

- a. Point your web browser to the [Global Customer Support](#).
- b. Select the **License Activation** tile from the **Knowledge & Support Center** options:

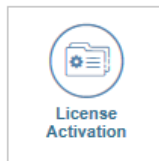

The **License Activation** Web Page appears.

- c. Browse to your saved .sync file created in step 2.b. and upload it in the **File to upload** field.
- d. Enter the text code and press **Upload File**.

The process request will create a file with a ".sync" file extension. The file name can be changed, but not the file extension.

- e. Save the file to a location where you can easily retrieve it from another computer on your network.

- 4. Receive offline deactivation on the License Manager node.

- a. From the License Manager node, click the yellow **Offline Activation** button. The **Offline Activation** dialog box opens.

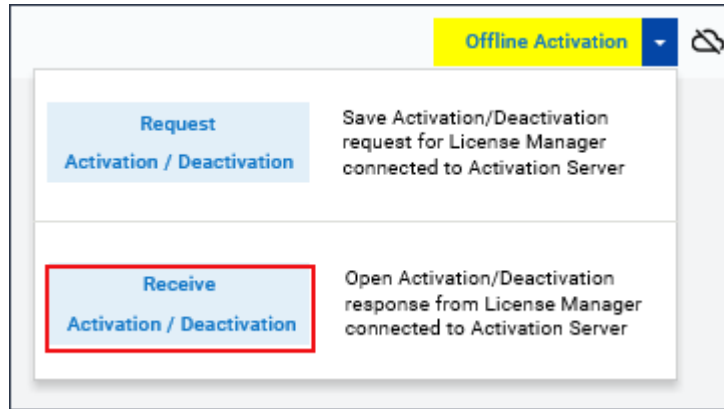

- b. Click the **Receive Activation / Deactivation** button. Navigate to the location where you saved the file. Select the file and click **Open**.

The selected licenses are removed from the grid and are no longer available for the products to use. You can activate these licenses on the same server or a different server at a later time.

Canceling a Pending Offline Activation/Deactivation

If you are using offline activation mode, you can cancel a pending activation or deactivation.

To cancel a request

1. If you have a pending activation/deactivation, marked in the license grid with "Pending Activation/Deactivation" in the status column, click to select the pending requests in the grid area.

| Quantity | Component Name | Part Number | Serial Number | Expiry Date | Status | Comment |
|----------|---|----------------|---------------|-------------|------------------------------|---------|
| 1 | Supervisory Client w/o HistClient 2017, no MSCAL | SupClt-02-N-17 | 1756849-0 | 6/27/2029 | Activated | |
| 1 | Supervisory Client w/o HistClient 2017, no MSCAL | SupClt-02-N-17 | 1756848-0 | 6/27/2029 | Activated | |
| 1 | Supervisory Client w/o HistClient 2017, no MSCAL | SupClt-02-N-17 | 1756850-0 | 6/27/2029 | Activated | |
| 10000 | System Platform 2017 IO Increment 1,000 | WSP-12-N-17 | 1763899-0 | 7/30/2021 | Activated | |
| 1 | System Platform 2017 Standard | WSP-01-N-17 | 1763897-0 | 7/30/2021 | Activated | |
| 1 | System Platform 2017 Professional | WSP-02-N-17 | 1763898-0 | 7/30/2021 | Activated | |
| 1 | Application Server 2017 5000 IO | WSPRT-02-N-17 | 1756829-0 | 6/27/2029 | Activated | |
| 1 | Application Server 2017 5000 IO | WSPRT-02-N-17 | 1756827-0 | 6/27/2029 | Activated | |
| 1 | Application Server 2017 5000 IO | WSPRT-02-N-17 | 1756828-0 | 6/27/2029 | Activated | |
| 1 | WW Historian Client/connection 2017 5 pack | Histo-21-N-17 | 1756844-0 | 6/27/2029 | Pending Deactivation Request | |
| 1 | WW Historian Client 2017 Concurrent 10 Pack | HstClt-03-N-17 | 1763891-0 | 7/30/2021 | Pending Deactivation Request | |
| 1 | Supervisory Client ReadOnly w/HistClient 2017, no MSCAL | SupClt-01-N-17 | 1756853-0 | 6/27/2029 | Pending Deactivation Request | |

2. Click **Cancel Pending Actions** above the license grid, and then confirm your action.

All licenses showing the status "Pending Activation/Deactivation request" or "Pending Activation/Deactivation" will be canceled if you click the **Cancel Pending Actions** button.

Acquiring Licenses for Backend Applications

Acquiring licenses for backend applications including the terminal services could be challenging due to several reasons, such as:

- Not possible to reserve licenses in terminal services session
- Unable to acquire a specific part number as multiple part numbers can exist for the same product
- No support for user-based reservations in InTouch

You can mitigate these challenges by creating the .avevalic configuration file and specifying the preferred part number to be acquired.

Create the .avevalic configuration file in the specific folders, and update the part numbers details. These part numbers will be automatically considered for license acquisition.

Note: License acquisition by specifying the part number details in the .avevalic configuration file is valid for terminal servers only at the time of this release.

To create the .avevalic configuration file

You can create the .avevalic configuration file locally at your own %USERPROFILE% directory. Alternatively, you can create a global.avevalic configuration file at C:\Program Data\AVEVA\Licensing.

To create the .avevalic configuration file:

1. Navigate to the location depending on the type of configuration file you want to create.
 - For a local configuration file, navigate to the %USERPROFILE% directory.
 - For a global configuration file, navigate to C:\Program Data\AVEVA\Licensing\.
2. Right-click anywhere in the folder and click **New > Text Document**.
3. Rename the new text document to .avevalic

In some cases, if you are not able to save the file name as '.avevalic' (dot avevalic), you can name the file as '.avevalic.' (dot avevalic dot).

Note: The .avevalic file available in %USERPROFILE% has precedence over the global .avevalic file located under Program Data.

To update the .avevalic file

To update the .avevalic configuration file with the details of the part numbers, follow the rules below:

- In the case of multiple part numbers, update the part numbers in the First-In-First-Out (FIFO) order.
- Separate multiple part numbers using a comma (,).
- Part Numbers entry can contain an asterisk '*', but it should not be used in the first or second part of the part number.
 - When '*' is used, the characters preceding the '*' are considered for matching, and the characters succeeding '*' are ignored.
 - If Part Numbers do not contain '*', then the whole part number is considered for matching
- Specify a user for each part number. Part numbers specified without a user will be applied for all the users.

- If a Part Number is invalid, it is logged as invalid and the next part number is considered for matching.

If any process is running as a service without an interactive user, the global configuration file and the part numbers available without a user map will be considered.

Sample .avevalic file

A sample.avevalic file can have the data as below:

Global .avevalic file

A sample global .avevalic file contains the part numbers as follows:

wwuser=Itch-05-n-17,Itch-10-n-17

wwuser2=Itch-04-U*

Itch-04-S-20, Itch-05-S-*

Hist-05-N-20

Itch-07-*-20

Local .avevalic file

The local .avevalic file contains the part numbers as follows:

Itch-30-*

Itch-04-S-20, Itch-05-*-20

Itch-10-*

Itch-04-N*

Configuring Permissions for .avevalic File

The .avevalic file available in %USERPROFILE% directory should be explicitly given permission to access AVEVA Enterprise License Product Service.

To configure permissions for .avevalic file

1. Navigate to %USERPROFILE% directory and locate the .avevalic file.
You can create the .avevalic file locally at your own %USERPROFILE% directory. For more information, see [Acquiring Licenses for Backend Applications](#).
2. Right-click the .avevalic file and select **Properties**.
The **.avevalic Properties** dialog box appears.
3. Select the **Security** tab and click **Edit**.
The **Permissions for .avevalic** dialog box appears.
4. Click **Add**.
The **Select Users, Computers, Service Accounts, or Groups** dialog box appears.
5. Click **Locations**.
The **Locations** dialog box appears.
6. Select the local computer and click **OK**.

The selected location appears in the **From this location** field.

7. In the **Enter the object names to select** field, enter the service name “NT SERVICE\AVEVA Enterprise License Product Service”.

8. Click **Check Names**.

If the name is valid, it appears underlined in the **Enter the object names to select** field.

9. Click **OK** to save your changes.

The AVEVA Enterprise License Product Service name is added to the **Group or user names** list.

Chapter 4

Administering AVEVA Enterprise Licensing

Administering a License Server

There are a number of administrative operations available to enhance management of your license server.

License Manager has two primary work areas: The License Server Summary Page, and the Details Page. All License Manager functionality is available from one of these two pages. Using License Manager, you can add or remove License Servers and you can start or stop the connected server. You can also pair two License Servers to enable server redundancy.

Adding and Removing a License Server

You can add or remove a License Server from the Server Summary Page of the License Manager. A License Server can be located on the SCADA network as a centralized License Server serving and managing all licenses across the network or the License Server can be the same node running the product software.

To add a License Server

1. Click **Menu** and select **Servers** from the menu. The **License Server Summary** page appears.
2. On the **Action Bar**, click **Add Server**. The **Add Server** panel appears.
3. Enter the License Server information.
 - a. Enter the name of the computer on which the License Server is installed.
 - b. Enter the name of the License Server as you want it displayed. By default, the computer name and the display name are the same.
 - c. Enter an optional description for the License Server, then click **Apply**. License Manager returns to the **Details** page and displays the details of the License Server you have just added.

You can start working with the new License Server. You can go back to the License Servers Summary page at any time by clicking the **Back Arrow** on the **Details** page.

For more information about using License Manager's features, see [Navigating License Manager](#).

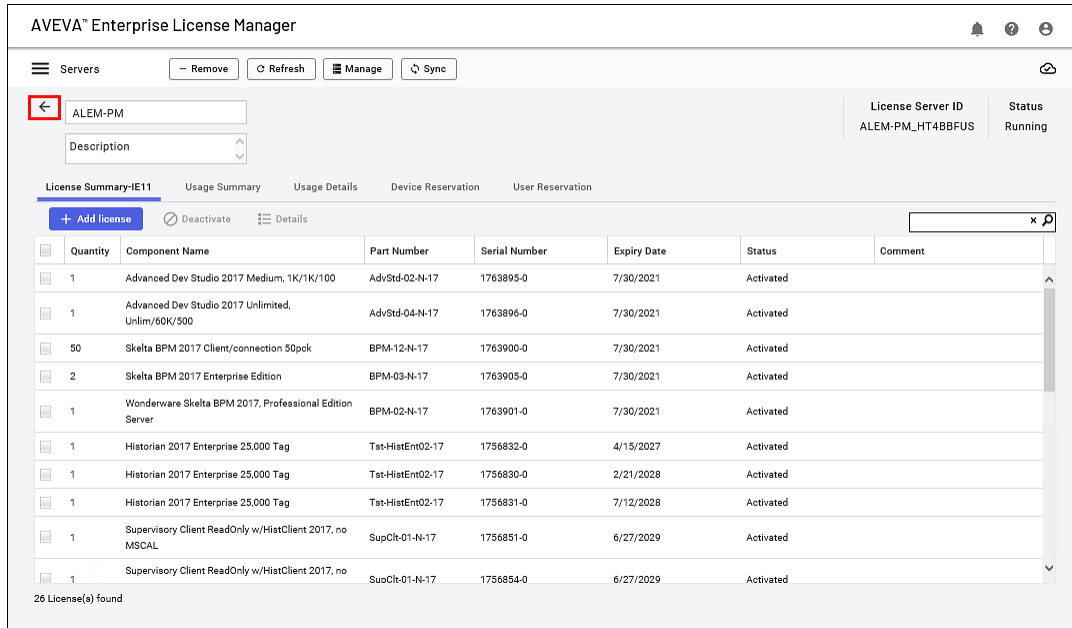

To remove a License Server

1. On the License Manager Summary Page, click the tile of the License Server you want to manage. The Details page will open, and will display detailed information about that server.
2. Click **Remove** on the **Action Bar** above the License Server name. After you confirm removal, the License Server Summary Page will display.
3. Select the License Server you want to view on the Details page.

Starting and Stopping a License Server

You can start and stop a License Server from the Action Bar on the Server Details page. Stopping a License Server will effectively suspend active licenses, including those in use by products you might be running.

Warning: Stopping a License Server could disrupt product operation. You should only stop a License Server for maintenance or troubleshooting purposes.

To stop a License Server

1. On the Server Details page, click **Manage** on the Action Bar.
The **Manage License Server** slide out panel appears.
2. Under **Maintenance**, click **Stop**.

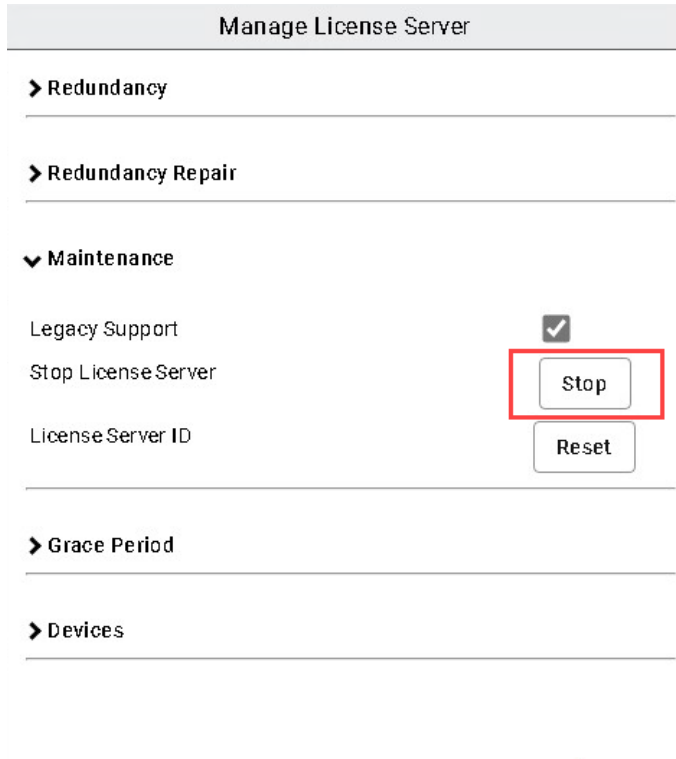

The server Status will change to "Stopped" in the Server Details information.



3. Click the left arrow to go to the License Servers page. The stopped server tile will have a red bar and show a "Stopped" status.

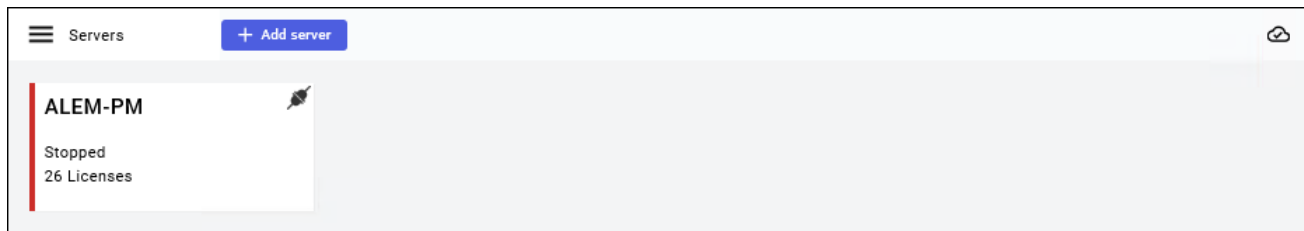

To start a License Server

1. On the Server Summary Page, select the stopped server tile. Click **Manage** on the Action Bar. The **Manage License Server** slide out panel appears
2. Under **Maintenance** , click **Start**.
The server Status returns to "Running" in the Server Details information.
3. Click the left arrow to go to the Server Summary Page. The server tile displays **Running** status.

Renaming a License Server

You can rename a license server, typically as part of managing computers on your network. There are several important points to keep in mind when renaming a license server:

- By default, the license server name displayed in the License Manager is the same as the computer name.
- You can change the license server display name inside License Manager without changing the computer (machine) name or the License Server ID.
- The License Server ID is a unique identifier used by other components of the licensing platform, including License Manager and the authentication server. A portion of the License Server ID is the host computer name. The License Server ID consists of the computer name plus a unique GUID (Globally Unique Identifier).

Important: As a highly recommended best practice, deactivate all licenses on the server before you rename the server. Reactivate the licenses after renaming the server.

If you do rename a License Server without first deactivating all licenses on the server, use the procedures outlined in the following scenarios to complete renaming your license server and reactivate your licenses.

License Server Co-located with License Manager

If the License Manager and the License Server exist on the same computer, and you have renamed the computer, you will see a message when starting License Manager that the computer has been renamed, and that you need to take additional steps to restore access to your licenses.

To reactivate licenses after renaming a server co-located with the License Manager

1. Deactivate all licenses on the server.
The server ID automatically resets after you have deactivated all licenses on that server.
2. Reactivate all licenses on the renamed server.

For information about how to deactivate and activate licenses, see [Activating and Acquiring Licenses](#).

License Server Remote from License Manager

If you rename a License Server installed on a computer separate from the computer on which License Manager is installed, that server will appear disconnected in License Manager.

To reactivate licenses after renaming a server remote from License Manager

1. Add a server to License Manager. See [Adding and Removing a License Server](#) for steps to do this.
2. Use the new computer name as the name of the server.
License Manager will detect the computer and server, and will be able to access the server. A message will appear that the server has been renamed, and that you need to deactivate and reactivate your licenses on that server.
3. Deactivate all licenses on the server.
The server ID will reset after you have deactivated all licenses on that server.
4. Reactivate all licenses on the renamed server.

For information about how to deactivate and activate licenses, see [Activating and Acquiring Licenses](#).

Renaming Redundant Servers

Renaming servers that are part of redundant pairs follows the same basic rules and procedures as non-redundant servers. As a best practice, you should deactivate licenses before renaming servers. If you rename a server in a redundant pair without first deactivating licenses, use the steps provided in the following topics to recover and reactivate your licenses.

Primary Server Co-located with License Manager

If the License Manager and the primary License Server of a redundant pair exist on the same computer, and you have renamed the computer, you will see a message when starting License Manager that the computer has been renamed, and that you need to take additional steps to restore access to your licenses. In this scenario, it is assumed that the backup computer is remote from the primary.

To reactivate licenses after renaming a redundant primary server co-located with the License Manager

1. Deactivate all licenses on the server pair.
The server ID automatically resets after you have deactivated all licenses on that server.
2. Unpair the redundant pair. For information about pairing and unpairing redundant servers, see [Working With License Server Redundancy](#).
3. Reset the server ID of the backup computer. For more information, see [Resetting the License Server ID](#).
4. Re-pair the redundant pair with the new License Server ID.
5. Reactivate all licenses on the renamed server.

For information about how to deactivate and activate licenses, see [Activating and Acquiring Licenses](#).

Primary Server Remote from License Manager

If you rename the primary License Server in a redundant pair installed on a computer separate from the computer on which License Manager is installed, that server will appear disconnected in License Manager.

To reactivate licenses after renaming the primary server in a redundant pair remote from License Manager

1. Add a server to License Manager. See [Adding and Removing a License Server](#) for steps to do this.
2. Deactivate all licenses on the server pair.
The server ID automatically resets after you have deactivated all licenses on that server.
3. Unpair the redundant pair. For information about pairing and unpairing redundant servers, see [Working With License Server Redundancy](#).
4. Reset the server ID of the backup computer. For more information, see [Resetting the License Server ID](#).
5. Re-pair the redundant pair with the new License Server ID.
6. Reactivate all licenses on the renamed server.

For information about how to deactivate and activate licenses, see [Activating and Acquiring Licenses](#).

Renaming Only the Backup Server

If you rename the backup server in a redundant pair without first deactivating all licenses on the pair, the backup server will appear in License Manager to have been shut down. This scenario assumes that the License Manager is not installed on the backup node, an atypical configuration.

To restore licenses on a backup server

1. In License Manager, add the backup server using the new server name.
See [Adding and Removing a License Server](#) for steps to do this. License Manager will detect the new server name.
2. Deactivate licenses on the redundant pair. For information about how to deactivate and activate licenses, see [Activating and Acquiring Licenses](#).
3. Unpair the redundant pair.
For information about pairing and unpairing redundant servers, see [Working With License Server Redundancy](#). The backup server will automatically reset the server ID. It will not preserve the original server ID.
4. Re-pair the computers as primary and backup servers.
5. Reactivate the licenses.

License Manager Installed on Both Primary and Backup Servers

Typically, a License Manager is not installed on both the primary and backup nodes of redundant License Servers, and this configuration is not recommended. However, this scenario can occur if a computer is configured with both License Manager and License Server, then cloned to create a computer to be used as a backup. This scenario also can occur when setting up redundant License Managers along with the redundant License Servers.

If you rename a backup License Server in a redundant pair co-located with a License Manager, you need to start the License Manager on the backup server node so it will sync with the primary computer.

Resetting the License Server ID

You can reset your License Server ID. Doing so allows you to create a new ID that will be used for future activation with the Activation Server.

For example, if a License Server has ever had activated licenses on it, it cannot be used as the backup server for a redundant pair. Resetting the ID will enable it to then be used as the backup. For more information, see [About License Server Redundancy](#).

The License Server ID can be reset if the following conditions apply:

- No licenses are activated on the server
- The server is not in the grace period
- The server is not paired with another server

To reset the License Server ID

1. Click **Manage** on the Action Bar.
The **Manage License Server** slide out panel appears.
2. Under **Maintenance**, click **Reset**.

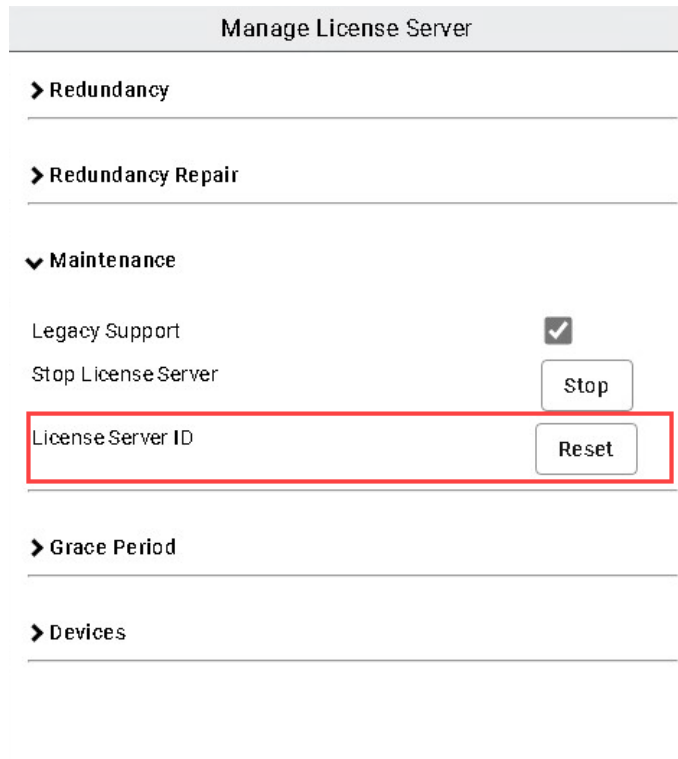

You will be prompted to confirm the License Server Reset. Upon click of **Yes**, the License Server ID will reset.

Syncing Licenses

The sync action regenerates the activated licenses in the License Server with the activated licenses in the Activation Server. For example, you may need to perform a sync action in the following scenarios:

- You have set up a redundant pair with a primary server that had activated licenses prior to pairing and is managed by an offline License Manager.
See [About License Server Redundancy](#) for detailed information.
- You are restoring an older image of a License Server that has fewer licenses.
See [Recovering from Hardware Failure by Re-Imaging Hardware](#) for detailed information.

To sync licenses

1. Click your server tile on the **Server Summary** page.
2. Click **Sync** on the **Action Bar**.

When the synchronization operation has completed, a notification will pop up stating that the License Server is synchronized with Activation Server successfully.

Syncing Licenses in Offline Mode

You can sync licenses in offline mode. In this mode there are two nodes involved to complete the process:

- A node with License Manager components installed and network access to a License Server but no Internet access to the Activation Server. The **Offline Activation** mode must be selected in the **Activation Settings** menu. See [Setting the Activation Mode](#) for details.
- A node with Internet access to the Activation Server and License Activation Web Page.

To sync licenses in offline mode

1. Request offline synchronization.
 - a. Click your server tile on the Server Summary page.
 - b. Click **Sync** on the **Action Bar**.

The synchronization request will create a file with a ".sync" file extension to send the request.
 - c. Save the file to a location where you can easily retrieve it from another node on your network.
2. Process offline synchronization using the License Activation Web Page on the node with Internet connectivity.
 - a. Point your web browser to the [Global Customer Support](#) website.
 - b. Select the **License Activation** tile from the **Knowledge & Support Center** options:

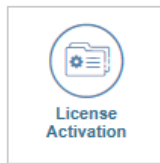

- The **License Activation** Web Page appears.
- c. Browse to the .sync file created in step 1.b. and upload it in the **File to upload** field.
 - d. Enter the text code and click **Upload file**.

The process request will create a file with a ".sync" file extension.
 - e. Save the file to a location where you can easily retrieve it from another node on your network.
3. Receive offline synchronization on the License Manager node.
 - a. From the Server Details page, click the yellow **Offline Activation** button. The **Offline Activation** dialog box opens.

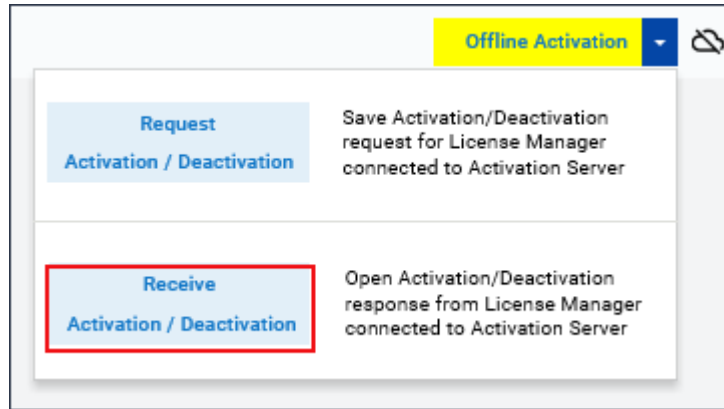

- b. Click **Receive Activation/Deactivation**. You will be prompted to locate the file. Locate the file and click **Open**.

When the synchronization operation has completed, a notification will pop up stating that the License Server is synchronized with the Activation Server successfully.

Working With License Server Redundancy

About License Server Redundancy

License server redundancy enables you to configure a pair of license servers to work in a synchronized manner to provide high availability of activated licenses.

When you configure a redundant pair, all actions associated with licenses, such as activation, acquisition, and reservations are kept in sync between both servers. If a license server fails, based on known conditions, the second server continues to operate with minimal impact on the operation of the licensed products. See [Monitoring Pair Status Information](#) for conditions that will cause a license server to fail.

The servers in the pair are commonly referred to as the primary server and the backup server. All data on the primary server is synced to the backup server. If the primary server fails, all its data is available on the backup server.

Requirements for Primary and Backup Servers

Certain License Server conditions must be met before license activation can succeed on a redundant pair. The primary server can have activated licenses at the time of pairing. However, the server you use as the backup cannot have activated licenses or any previous license activations. If licenses are currently or have previously been activated on the backup server prior to pairing, the License Server ID must be reset for the backup server before licenses can be successfully activated on the pair. See [Resetting the License Server ID](#) for detailed instructions.

You can configure a redundant pair with a primary server with or without licenses on it. When the primary server is hosting activated licenses and is managed by an offline License Manager, you must click the **Sync** button after pairing the servers. This will synchronize the existing licenses with the backup server and complete the pairing.

Note: The Pair Status in the Server Details Page will display as **Pair not synced** until you perform the sync action.

Basic Topology for License Server Redundancy

Setting up a redundant pair requires two nodes where the License Server and License Manager components are installed. For more information about installing licensing components, see [Installing License Manager and License Server](#).

A basic configuration of redundant license servers is shown in the following diagram. For detailed topology models, see [Redundancy Topologies](#) (see [Redundancy Topologies](#) on page 32).

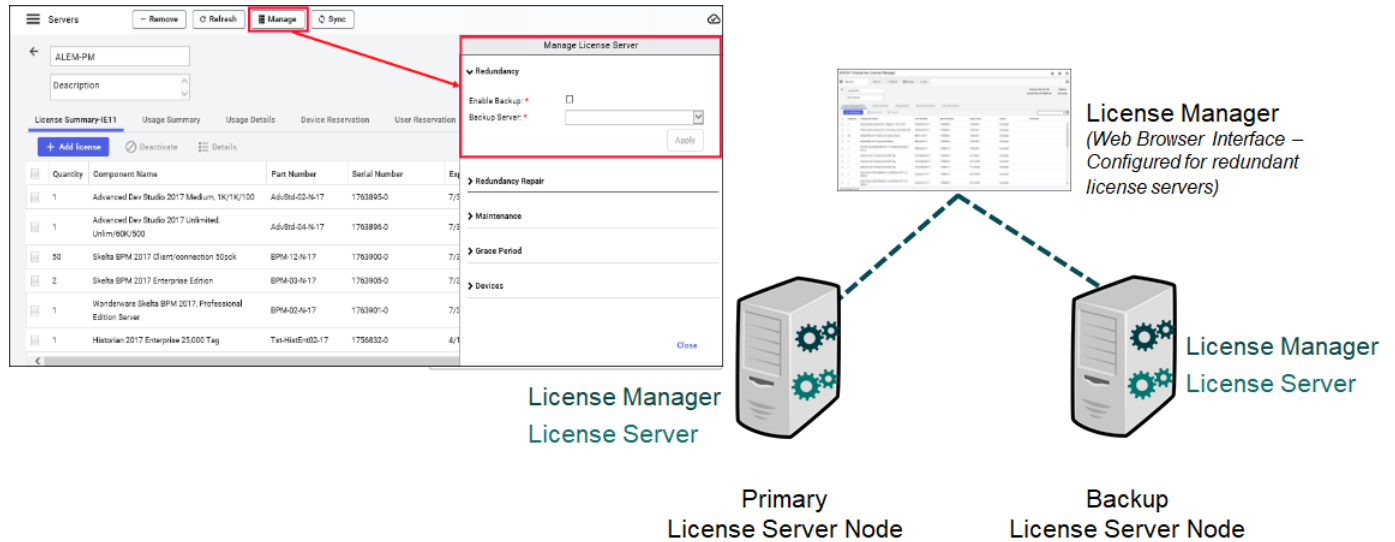

For more information about configuring license server redundancy, see [Enabling License Server Redundancy](#).

For more information about renaming redundant license servers, see [Renaming a License Server](#).

Note: Any license server can only be part of one redundant pair.

Enabling License Server Redundancy

To enable a license server redundancy

1. Launch License Manager by pointing your web browser URL to the primary node (Node 1 in the diagram above).

The primary license server will be automatically added to the primary License Manager upon launch.

2. Add the backup license server to the primary License Manager.

See [Adding and Removing a License Server](#) for more information.

3. Select the tile of the primary license server to access the **Server Details Page**.

Note: The selected server will be the primary server.

- a. Select **Manage** from the **Action Bar**.

The **Manage License Server** slide out panel appears.

- b. Under **Redundancy**, select **Enable Backup**.

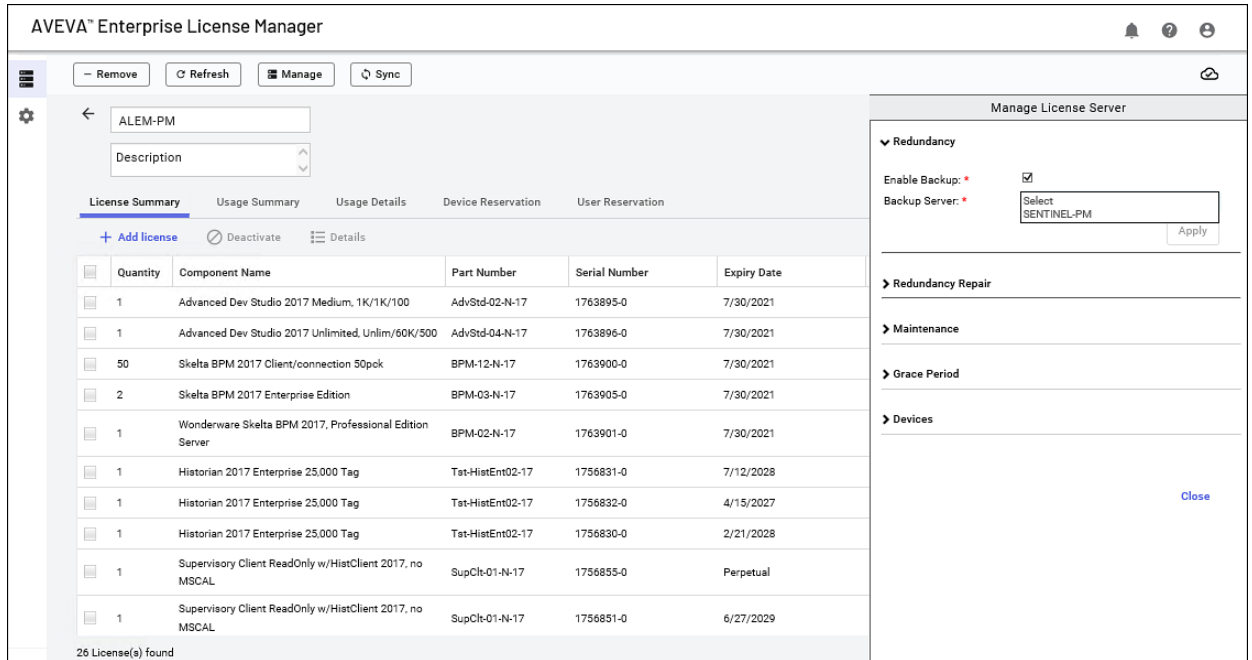

- a. Select your second server from the list box and click **Apply**.

Note: The redundant server should not have activated any license before. If it has activated any license, you need to deactivate all the licenses and reset the server ID under **Manage** option. The Activation Server should not have the backup server ID.

The **Server Details Page** will now display your primary and backup servers and their pair status information.

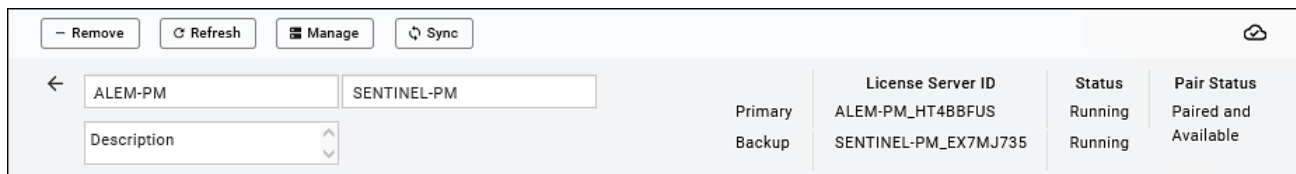

In the **Server Summary Page**, the redundant pair appears as a single tile displaying the names of both servers in the pair.

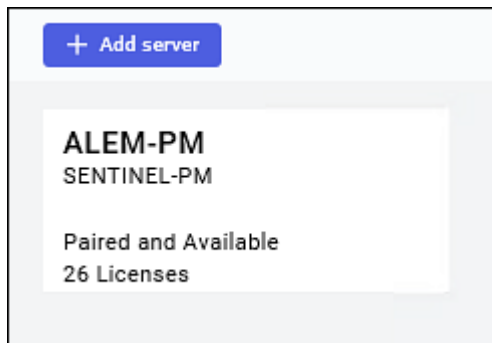

Note: Once you have activated licenses on the pair, you cannot undo the pairing until all licenses have been deactivated. Once paired, point your browser to the License Manager on the backup license

server node. The redundant pair will automatically be added to the backup License Manager upon launch.

4. Enable licensing redundancy for your licensed product by running the **Configurator** tool on the node where the product is installed.
 - a. Open **Configurator** from **Start>All Programs**.
 - b. In the **Primary Server Name** field, enter the name of the primary server.

Note: The backup server associated with the primary server is automatically configured based on the configuration in License Manager. This configuration applies to all products installed on the node.

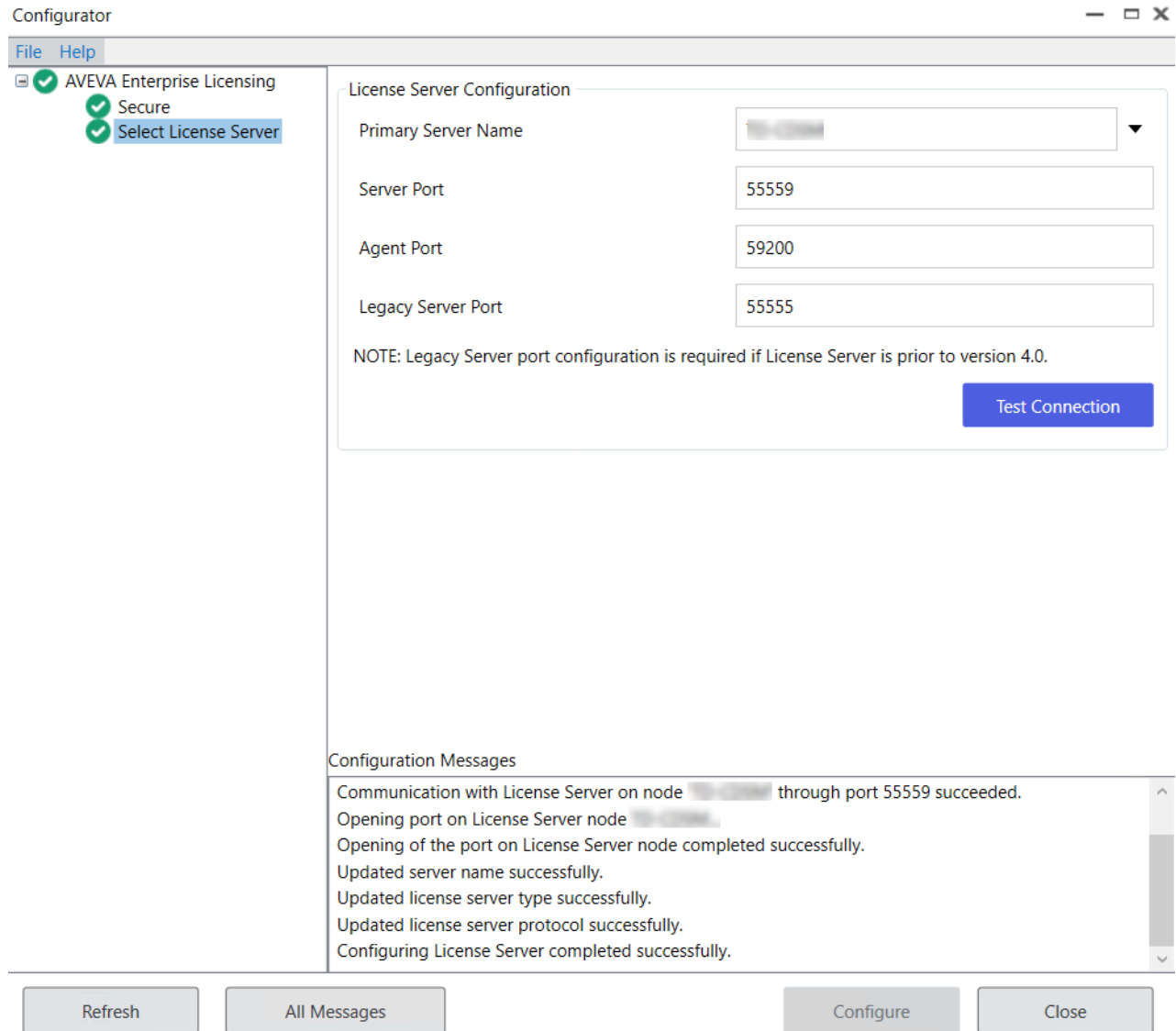

- a. Click **Test Connection**.
- b. Click **Configure**.

Monitoring Pair Status Information

The pair status information displayed in the Server Details Page provides you with identifying information and the connection statuses of both servers in the pair. If both servers are running and can be accessed over the network they are hosted on, the pair status information displays as follows in the Server Details Page:

| | License Server ID | Status | Pair Status |
|---------|----------------------|---------|----------------------|
| Primary | ALEM-PM_HT4BBFUS | Running | Paired and Available |
| Backup | SENTINEL-PM_EX7MJ735 | Running | Available |

There are a number of conditions that will trigger a change in the Pair Status. The conditions and corresponding status changes are listed below. In these examples, the condition occurs on the backup server.

- The backup server node shuts down
 - Backup server status changes to: **Disconnected**
 - Pair status changes to: **Backup not available**
- The backup server loses network connection or is stopped
 - Backup server status changes to: **Stopped**
 - Pair status changes to: **Backup not available**
- The backup server is uninstalled
 - Backup server status changes to: **Backup not available**
 - Pair status changes to: **Backup not available**
- The pair is not synced
 - Both server statuses remain as **Running**
 - Pair status changes to: **Pair not synced**

See [About License Server Redundancy](#) for details on this scenario.

For example, if the backup server was stopped, the statuses would appear as follows:

| | License Server ID | Status | Pair Status |
|---------|----------------------|---------|----------------------|
| Primary | ALEM-PM_HT4BBFUS | Running | Backup not available |
| Backup | SENTINEL-PM_EX7MJ735 | Stopped | available |

The pair status information is also reflected on the server tile in the **Server Summary Page**. If both servers in the pair are connected and running, the tile displays **Paired and Available**. If the pair is not available, the server tile will reflect whichever server is unavailable.

The following images show how the pair status is displayed in the server tile.

Pair Available Server Tile

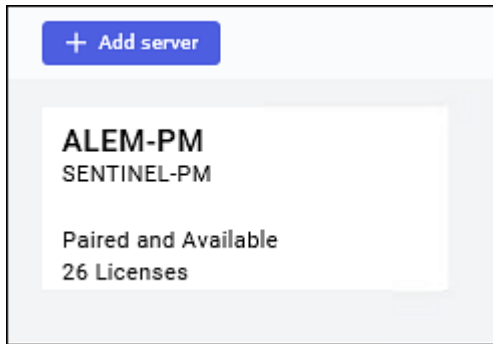

Pair Not Available Server Tile

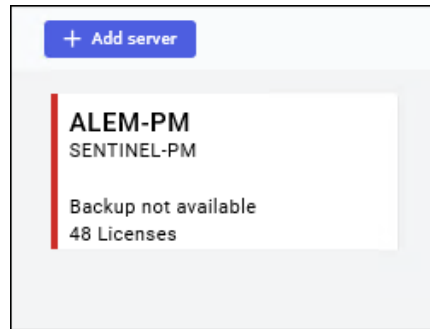

Repairing the Primary Server

In the License Server redundant pair, if the primary license server is not accessible or is offline, you can repair the primary license server with a new license server.

To Repair the Primary License Server

We can repair from either primary server (new machine) or from backup server.

Repairing from backup server:

1. Install the License Server in a new machine which has the same machine name as the primary server.
2. In the backup server, the two servers are displayed as paired.
 The primary machine will be marked as "Disconnected".
3. Manually add the primary server to the backup server machine again using **Add Server** option. For more information on how to add a license server, see [Adding and Removing a License Server](#).
 Now as part of the original pair server tile, the primary server will be marked as "ERROR".
4. Select the paired servers tile. In the **License Server Summary** page and click **Manage**.
 The **Manage License Server** slide out panel appears.

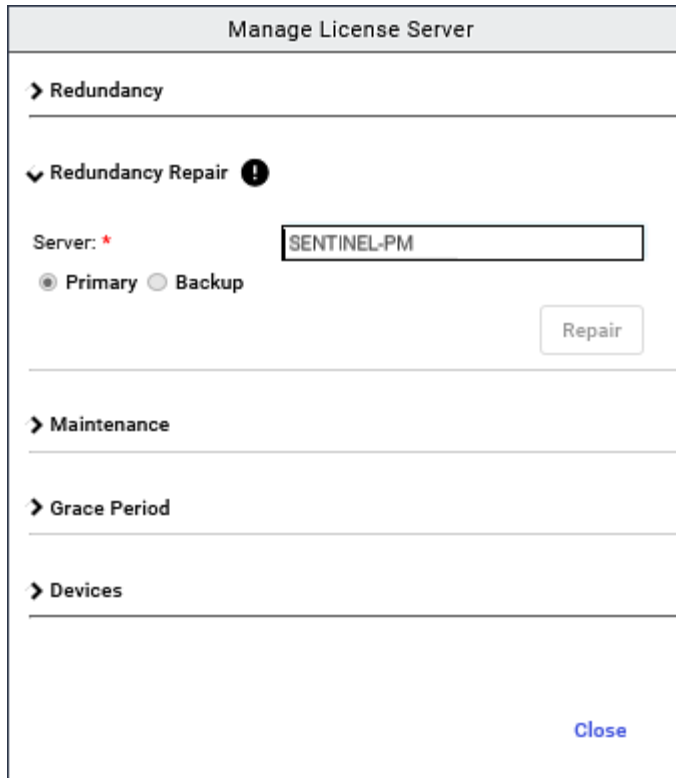

5. Under **Redundancy Repair**, in the **Server** field, select the primary License Server name and click **Repair**.

A confirmation belly bar appears asking for the confirmation to repair the primary server.

6. Click **Yes**, if you want to continue.
7. Go to new primary server machine and open License Manager.
8. Click **Refresh** to refresh the window.

Both the license servers are paired and appear in a single tile.

Repairing from primary server (new machine):

1. In the primary server, install and launch License Manager. The machine will be added as single server in connected state.
2. Manually add the backup server in License Manager available in primary server node using **Add Server** option. For more information on how to add a license server, see [Adding and Removing a License Server](#).

3. Backup server is added along with primary server as paired.

The primary machine will be marked as "ERROR".

4. Select the paired server tile. In the **License Server Summary** page, click **Manage**.

The **Manage License Server** slide out panel appears.

5. Under **Redundancy Repair**, in the **Server** field, select the primary license server name and click **Repair**.

A confirmation belly bar appears asking for the confirmation to repair the primary server.

6. Click **Yes**, if you want to continue.
 7. Click **Refresh** to refresh the window.
- Both the license servers are paired and appear in a single tile.

Disabling the License Server Redundancy

Prerequisites to disable the license server redundancy are:

- At least one of the paired servers should be available.
- The available server should not have any activated licenses.

To disable license server redundancy from a server

1. Select the tile of the primary license server to access the **Server Details Page**.
2. Select **Manage** from the **Action Bar**.
3. The **Manage License Server** slide out panel appears.
4. Under **Redundancy**, uncheck **Enable Backup** check box and click **Apply**.

Note: If one of the server is no longer available and there are any activated licenses in that server, a message prompting to contact technical support for further assistance appears. Deactivate the license with technical support assistance, perform sync operation (see [Syncing Licenses](#)) to remove licenses from License Manager and then disable the redundancy as mentioned in the above steps.

Recovering from Hardware Failure by Re-Imaging Hardware

If you encounter hardware failure on the node hosting your License Server and choose to re-image your machine, the License Server will enter a grace period. The grace period allows you to continue performing normal licensing functions on the re-imaged License Server without interruption. You have the duration of the grace period mode to rectify the grace period mode before the License Server stops allowing licenses to be acquired.

If you had activated licenses on your License Server at the time of the hardware failure, you can continue using them after you end the grace period if you follow the steps below.

Note: If the image you restored was not concurrent with the License Server at the time of hardware failure, you may have to perform a sync action so that the License Server reflects the most current licenses. See [Syncing Licenses](#) for more information about syncing licenses.

To end the grace period and keep licenses on a re-imaged license server

1. Click **Manage** on the **Action Bar**.
The **Manage License Server** slide out panel will appear.
2. Under **Grace Period**, enter the Exit Grace Period code in the text box.
The **End Grace Period and Keep Activated Licenses** option will be enabled.

Note: Contact technical support to request the Exit Grace Period code.

3. Click **Apply**.
The re-imaged License Server will no longer be in the grace period and will continue to operate in its normal state.

For details on ending the grace period in a virtual environment, see [Working with the Grace Period](#).

Using Command Line License Administration

The AVEVA Enterprise License Administration command tool emulates in command line format some of the functions of the licensing subsystem's license administration tool. The command line tool enables you to add a local or remote license server to your License Manager, import an entitlement, and activate all licenses on that entitlement using the command prompt tool rather than the application interface.

Important: You must have at least local administrative privileges within your local hosting process or remote to use command line activation. This tool can only be used on a node where the full License Manager directory has been installed, and only supports online activation.

Using Command Line Functionality

The syntax for using the command line tool is organized around three basic operations:

1. The "import" action allows entitlements to be imported and licenses in the entitlements to be optionally activated against a license server node.
2. The "addserver" action allows one or more license servers to be added to a License Manager instance.
3. The "deactivate" action allows the user to deactivate licenses associated with a particular license server.

Do the following

1. Open the command prompt from **Start, Run**.

The **Run** dialog box appears.

2. Enter "cmd" in the listbox.
3. Change the directory to the License Administration command tool install location: C:\Program Files(x86)\Common Files\Archestra\Licensing Framework\License Manager\LMWebApp\bin\AELicManagerCmd.

Note: You can access command line help at any time by entering any of the following into the command prompt: -h, -H, or ?. For example: C:\Program Files (x86)\Common Files\Archestra\Licensing Framework\License Manager\LMWebApp\bin\AELicManagerCmd ?

4. Enter the following syntax to complete the "addserver" operation:

AELicManagerCmd addserver -n <nodename>, where <nodename> is the name of the node with the license server directory installed. For example:

```
C:\Program Files (x86)\Common Files\Archestra\Licensing Framework\License Manager\LMWeb.App\bin\AELicManagerCmd addserver -n RM-NGLMv3
```

A "Success" status will appear beneath each line of syntax to indicate the action was successful.

5. Enter the following syntax to complete the "import entitlement" and "activate" operations:

AELicManagerCmd import -e <folder path> -n<nodename> -a, where <folder path> is the folder location of the entitlement you want to import. For example:

```
C:\Program Files (x86)\Common Files\Archestra\Licensing Framework\License Manager\LMWeb.App\bin\AELicManagerCmd import -e C:\Users\Documents\License Entitlement.xml -n RM-NGLMv3 -a
```

Note: If you do not want to activate your licenses after the import operation, remove -a from the end of the command syntax. If you choose not to use the -a switch you must activate your licenses through the UI or run the command again with the -a switch.

There is no separate "activate" command. The "import, activate" command can be run to activate licenses. This will not import the entitlement again.

Deactivation

To complete the "deactivation" operation enter the following syntax :

AELicManagerCmd deactivate -n <nodename>, where <nodename> is the name of the node with the License Manager directory installed. For example:

```
C:\Program Files\<install directory> AELicManagerCmd deactivate -n RM-NGLMv3
```

Managing the Licensing System in a Virtual Environment

The AVEVA Enterprise licensing functionality is the same in both hardware and virtual environments. It is important to deactivate all activated licenses before moving or copying an image of a virtual or hardware node. When a license is activated it is associated to a uniquely identified license server. When the above actions are performed on the virtual image hosting the license server, the unique identification may change and impact the activated license.

When the license server unique identification changes, the server enters a [grace period](#) (). The grace period allows you to continue performing normal licensing functions on the license server hosted on the cloned or copied image without interruption. The grace period lasts fifteen days. You have the duration of the grace period to update the licenses on the cloned or copied image.

Managing a License Server on a Virtual Image

Below are the recommended steps to manage the virtual image hosting a license server.

| Action | Initial State | Planned Change | Recommended Procedure |
|--|--|---|--|
| Moving a virtual image hosting the license server | A virtual image hosting a license server with activated licenses | Move the virtual image to a different host | Deactivate all licenses before moving the image. Activate licenses again after moving. |
| Moving the hosted server from a hardware node to a virtual image | A hardware node hosting a license server with activated licenses | Move the hardware image to a virtual environment | Deactivate all licenses before moving the image. Activate licenses again after moving. |
| Cloning a virtual image hosting the license server | A virtual image hosting a license server with activated licenses | Create template of the base image for cloning and distribution to other locations | Deactivate all licenses on base image. Clone the image. Activate licenses again on the cloned image. |

| | | | |
|--|--|----------------------------------|---|
| Reverting to a Snapshot of a Virtual Image | A virtual image hosting a license server with activated licenses | Revert virtual image to snapshot | Do not shut down product. Revert image to snapshot. Snapshot will become current image and product will continue running with acquired licenses. Press the Sync button to refresh all current licenses on the License Server. |
|--|--|----------------------------------|---|

Managing a Licensed Product Virtual Image

| Scenario | Start State | Planned Change | Procedure |
|--|--|---|---|
| Moving a Virtual Image with Licensed Products whose License Server is Hosted on Another Node | Licensed products with acquired licenses on a virtual image | Move licensed products to another host | Shut down each product to release acquired licenses. After the image is moved to a new host and the product restarted, licenses will be acquired. If the license server has changed, configure moved products to the new server. |
| Moving Licensed Products from a Hardware Environment to a Virtual Image | Licensed products with acquired licenses on a hardware image | Move licensed products to a virtual image | Shut down each product to release licenses. After the image is moved to a virtual host and the product restarted, its licenses will be acquired. |
| Cloning a Virtual Image with Licensed Products | Licensed products with acquired licenses on a virtual image | Create template of the base image for cloning and distribution to other locations | Shut down the product to release licenses. Clone the image. Install and configure product and acquire licenses on the cloned image. |

| | | | |
|---|--|-----------------------------------|--|
| <p>Reverting a Snapshot of a Virtual Image with Licensed Products</p> | <p>Licensed products with acquired licenses on a virtual image</p> | <p>Revert image to a snapshot</p> | <p>Do not shut down product. Revert image to snapshot. Snapshot will become current image and product will continue running with acquired licenses.</p> <p>Only the licenses available before the snapshot was created will be available after reverting the snapshot.</p> |
|---|--|-----------------------------------|--|

Renaming the License Server Node

Make sure all licenses are deactivated before renaming the node where the License Server is installed.

If you rename the node while licenses are activated on the License Server, the licenses become invalid and cannot be acquired. Additionally, the licenses cannot be reactivated unless you contact technical support to recover your licenses.

Working with the Grace Period

When you clone or copy a virtual image hosting a license server, the server will enter a [grace period](#) (). The grace period allows you to continue performing normal licensing functions for a limited time on the virtual image of the cloned or copied license server without interruption. The grace period lasts fifteen days. You have the duration of the grace period mode to rectify the grace period mode before the server stops allowing licenses to be acquired.

Note: When you clone or copy a virtual image hosting a license server, the license server may intermittently enter into grace period. However, if the license server is ready in the next cycle, it may come out of the grace period automatically.

The following status appears in the tile of the server that has entered the grace period:

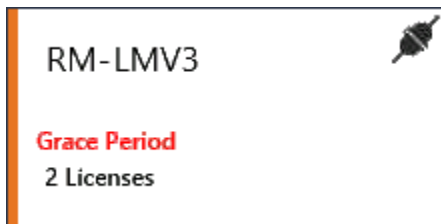

The grace period notification also appears in the **Server Details** page beside the **Activation Server Connection** icon. You will see this icon:



Click this icon to see a list of any license servers in the grace period. The list also displays the expiration date and time of each server's grace period. You can navigate to each server from this list.

Once your license server enters the grace period, you will have fifteen days to exit the grace period and update your licenses. Otherwise, the server will stop functioning and will not allow licenses to be acquired.

Ending the Grace Period

There are two options for ending the grace period. Your selection will depend upon whether you want to use the licenses from the server on the base image for the server on the cloned image, or whether you want to activate new licenses for the server on the cloned image.

The procedures for both cases are described in the following scenarios.

Scenario 1: New Licenses for Server on Cloned Image

You have cloned the image hosting your license server. The server on the cloned image has entered the grace period. You want to leave the server on the base image intact with its licenses and activate new licenses on the server hosted on the cloned image.

To end the grace period, do the following

1. Click **Manage** on the **Action Bar**.
The **Manage License Server** slide out panel appears.
2. Under **Grace Period**, click **Apply** next to the End Grace Period and Remove Activated Licenses option.

Note: This will clear all licenses from the server hosted on the cloned image. All licenses on the original image will remain functional. This action is not recoverable.

The license server hosted on the cloned image will no longer be in the grace period and will continue to operate in its normal state.

Scenario 2: Same Licenses for Server on Cloned Image

You have cloned the image hosting your license server. The server on the cloned image has entered the grace period. You want to continue using your licenses with the server on the cloned image. This requires that the server on the base image be deleted. You cannot operate with the same licenses on two nodes.

To end the grace period, do the following

1. Click **Manage** on the **Action Bar**.
The **Manage License Server** slide out panel appears.
2. Contact technical support to request the Exit Grace Period code.
3. Under **Grace Period**, enter the Exit Grace Period code in the text box.

Important: Delete the license server on the base image before contacting Technical Support.

3. Under **Grace Period**, enter the Exit Grace Period code in the text box.
The **End Grace Period and Keep Activated Licenses** option will be enabled.
4. Click **Apply**.

The license server hosted on the cloned image will no longer be in the grace period and will continue to operate in its normal state.

Note: If you have a redundant pair and one or both servers is in grace period, only the End Grace Period and Keep Activated Licenses option will appear in the Manager License Server panel. The same Exit Grace Period code will end either or both grace periods.

Ending the Grace Period in Offline Mode

You can end the grace period in offline mode. In offline mode the server hosted on the cloned image must communicate with the Activation Server to exit the grace period. The procedure for ending the grace period in offline mode is therefore the same as activating licenses in offline mode.

The following procedure applies to Scenario 2.

You have cloned the image hosting your license server. The server hosted on the cloned image has entered the grace period and is in offline mode. You want to continue using your original licenses on the server hosted on the cloned image.

To exit the grace period in offline mode do the following

1. Contact technical support to request the Exit Grace Period code.

Important: Delete the server on the base image before contacting Technical Support.

2. On the server hosted on the cloned image, enter the Exit Grace Period code in the text box.

The **Apply** next to the End Grace Period and Keep Activated Licenses will be enabled.

3. Click **Apply**.

Reset Grace Period will appear as a pending activation in the license grid.

4. Follow the procedure for activating licenses in offline mode.

For details, see [Activating Licenses in Offline Mode](#).

5. Upon click of **Receive Activation/Deactivation**, the server hosted on the cloned image will exit the grace period.

The license server hosted on the cloned image will no longer be in the grace period and will continue to operate in its normal state.

Note: Upgrading certain versions of AVEVA Enterprise Licensing can result in a grace period. End this grace period by syncing licenses in the license server. For information on how to sync licenses, refer to [Syncing Licenses](#).

If the license server is in a Grace Period prior to upgrade, it will remain in Grace Period following upgrade. To end the Grace Period after upgrading, you will need to contact Technical Support to obtain a Grace Period exit code. To avoid this scenario, end the Grace Period before upgrading to a newer License Server version.

Reasons a license server enters grace period

- Moving a VM from one environment to another typically invalidates the original.
- Cloning or copying a License Server.
- Exporting a Virtual Hard Drive (VHD) from one system to another, then using it to set up a new VM.
- Upgrading to the latest version in Hyper-V and Azure virtual machines.
- Upgrading from version 3.0 to the latest version.
- License Servers in a Disaster Recovery virtual environment during DR activities.
- Disaster Recovery (DR) in a Hyper-V virtual environment activates a licensing grace period.
- Disaster Recovery (DR) in a VMWare virtual environment activates a licensing grace period.

- If you encounter hardware failure on the node hosting your License Server and choose to re-image your machine, the License Server will enter a grace period.
- When the license server's unique identification changes, the server enters a grace period.

Monitoring License Server Health

Monitoring License System Health

Sentinel System Monitor (Sentinel) is an application that monitors and manages the health, performance and availability of your AVEVA system. Sentinel Basic mode monitors the connectivity of the licensed nodes on the control network to one or more License Servers. In addition, the Basic mode also enables full functionality of Sentinel on one node so users can see how it works.

Full functionality of Sentinel monitors and manages the performance and availability of your AVEVA system, including the core software, the engineered software application(s), node connectivity to the License Server, and the related hardware and network infrastructure.

Sentinel detects messages and reports on system performance issues/errors/trends, and monitors key system attributes, and then generates alerts when those attributes exceed defined tolerance ranges.

When an attribute is out of tolerance, the customer support team (internal, systems integrator, and/or Technical Support) is notified of the upset condition, and can respond proactively in order to prevent production interruption or downtime. The goal is to ensure that the performance of your solution meets and exceeds your expectations. Full functionality Sentinel is available for purchase separately.

Set up for Sentinel running in basic mode

1. Carefully select a reliable machine to host Sentinel, and it is recommended that the Sentinel machine is a different machine than your License Server machine(s).
2. Following installation of Sentinel, in the Configurator under Sentinel Manager, input your SMTP server information.
3. On other product nodes, install the product software as usual. Following installation of the product software, in the configurator under Sentinel Agent Install Manager, input the host name or IP address of the Sentinel Manager server.
4. Monitoring of license acquisition will begin immediately following these steps.

Reserving Licenses

The AVEVA Enterprise Licensing model supports concurrent and reserved licenses. By default, all licenses are managed as concurrent licenses. In the concurrent license model, devices and users acquire licenses on a first-come-first-served basis.

The reserved license model ensures that specific devices or users are assigned a license. Only one reservation can be placed on a license at a time. However, if a single license contains multiple parts, such as more than one client, each part can be reserved individually. Once all concurrent licenses are acquired, any new users or devices are denied a license unless it has been reserved for them or concurrent licenses become available.

If you have multiple of the same license, for the same product hosted in the same License Server, reservations are not needed. However, if one or more licenses have unique functionality, then reservations are needed to ensure that the proper devices acquire those unique licenses.

Important: Reserving a license that is currently acquired by a device other than the device assigned in the reservation does not release the license from the device. The reservation takes effect the next time the license is released, and the assigned device acquires the license.

There are two types of license reservation:

- **Device reservation**

Reserving a specific product license to a device guarantees that a user accessing that device can use the reserved license as long as the user is authorized by the licensed product.

Licenses can be reserved for any type of device, depending upon the configuration and functionality of the product.

Servers or back end type applications can only be reserved for devices as they typically run as a background service, and will always use the computer name on which this back end runs. Clients or connection licenses can also be reserved for devices, but the expected device identification might vary with the product. Refer to your specific product documentation for more information.

For more information about reserving licenses for devices, see [Reserving Licenses for Devices](#).

- **User reservation**

Reserving a license for a specific user guarantees that the user can use the reserved license as long as the user is authorized by the licensed product.

User reservation is the primary use case for reserving connection licenses. Reserving licenses to a user is helpful when the same user needs access to the application from different devices at different times, and be guaranteed to have a license available when needed.

For some products, a license will be reserved for a user automatically when the product acquires the license. No manual reservation procedure is necessary in these cases.

For more information about reserving licenses for devices, see [Reserving Licenses for Users](#).

Note: The device and user identifiers entered when reserving licenses must match the device and user identifiers known to the relevant computer or domain.

There are two methods for license reservation:

- You can use the **Device Reservation** and **User Reservation** tabs in the **Server Details** page. For more information about reserving licenses for devices and users, see [Reserving Licenses for Devices](#) and [Reserving Licenses for Users](#), respectively.
- You can export, edit, and import a <Reservations>.csv file. This file has the details of the Device Reservations or User Reservations. For more information, see [Exporting and Importing Reservations for Devices](#) and [Exporting and Importing Reservations for Users](#).

Reserving Licenses for Devices

Reserving a specific product license for a device guarantees that a user accessing that device can use the reserved license as long as the user is authorized by the licensed product.

Licenses can be reserved for any type of device, depending upon the configuration and functionality of the product.

Servers or back end type applications can only be reserved for devices as they typically run as a background service, and will always use the computer name on which this back end runs. Clients or connection licenses can

also be reserved for devices, but the expected device identification might vary with the product. Refer to your specific product documentation for more information.

Note: The device identifier entered when reserving licenses must match the device identifier known to the relevant computer or domain.

Reserve licenses for devices

1. In the **Servers Details** page, click the **Device Reservation** tab.
2. Click **Add Device**.
The **Add Device** dialog box appears.
3. In the **Device Name** box, type the name of the device for which you want to reserve the license.
4. In the **Comment** box, type any additional information about the device reservation.
5. You can also use the Search bar to search for the features. Enter a partial or complete Feature name, or Part Number, or Version, and click the Search icon. The grid displays all the features that contains the given search criteria.
6. From the list of features, select the check boxes for the features you want to reserve for the device.
Some part numbers have multiple features associated with it. If such a part number is selected, then all features associated with the part number are reserved for the device.
If you want only some of the features associated with the part number to be reserved, not all, then:
 - a. Click on the three dots next to the **Part Number** grid, and then click **Select Partial**.
 - b. The grid displays all the individual features associated with the part number. Select the checkboxes of the feature(s) you want to reserve for the device.
7. Click **Add**.
The device and the selected features are displayed in the **Device Reservation** tab.
8. Click **Apply** to apply the changes.
The changes are applied to the selected device.

Video Tutorial: Reservations and Checkouts



Exporting and Importing Reservations for Devices

You can export the device reservation details to a .csv file. After exporting the .csv file, you can edit the file to update any existing reservations or add new reservations. If any of the listed licenses is not reserved for a device, you can add the device name to which you want to reserve the license. You can then import the edited file to the License Manager to update the device reservation details.

To export the Device Reservation Details

1. In the **Servers Details** page, click the **Device Reservation** tab.
2. Click **Export**.
A message appears asking you to save the reservation details.

3. Click **Save**.
4. Browse for the location to save the .csv file.

The .csv file is saved with the default filename **Reservations-<DeviceName>-<Date Time>**.

For example, if you exported the reservation details for the device “AELM-1” on January 2, 2020, at 14:30, then the filename is **Reservations-AELM-1-02-01-2020 14_30_00**.

5. Click **Save**.
6. Open the .csv file.

The following details are available:

- Device name
- Count
- Feature
- Part number
- Version
- Expiry
- Checkout
- Comment

If you reserve partial features associated with a part number, then the reserved features of that part number and their count appear after the aforementioned details.

To edit the .csv file

1. Browse to the location where the .csv file is available.
2. Open the .csv file.
3. Edit the file as required. If any of the listed licenses is not reserved for a device, you can add the device name to which you want to reserve these licenses.
4. Save the .csv file.

To import the Device Reservation Details

1. On the **Servers** Details page, click the required server tile.
2. Click the **Device Reservations** tab.
3. Click **Import**.
4. Browse to the location where the .csv file is available.
5. Select the .csv file and then click **Open**.
6. Click **Apply**.

The updated reservation changes appear in the grid.

Canceling, Deleting, or Clearing Device Reservations

You can cancel the reservation changes or delete a device reservation. You can also clear all the device reservations and unreserve all the licenses.

Canceling the License Reservation for Devices

To cancel all the device reservation changes made, which are yet to be applied:

1. In the **Servers Details** page, click the **Device Reservation** tab.
2. Click **Cancel**.

A message appears asking your confirmation to cancel all the changes.

3. Click **Yes**.

All the changes made in the **Device Reservation** tab, which are yet to be applied, are canceled.

To cancel the reservation changes for a newly added device, where the changes are yet to be applied:

1. In the **Servers Details** page, click the **Device Reservation** tab.
2. Click the **Cancel** (✖) icon for the device reservation that you want to delete.

A message appears asking your confirmation to cancel the row.

3. Click **Yes**.

The selected device reservation is canceled.

Deleting Device Reservations

1. In the **Servers Details** page, click the **Device Reservation** tab.
2. In the **Action** column, click the **Delete** (🗑) icon for the device reservation that you want to delete.

The details of the selected row are struck out.

Note: The **Delete** icon is disabled for checked out licenses.

3. Perform either of the following:

- If you want to apply the changes, click **Apply**.
The selected device reservation is deleted.
- If you want to cancel the changes, click the **Cancel**. In the **Confirmation** dialog box, click **Yes** to cancel all the changes.

The changes made to the device reservation(s), which are yet to be applied, are canceled.

Clearing all Device Reservations

1. In the **Servers Details** page, click the **Device Reservation** tab.
2. Click **Clear All**.

A warning message appears asking your confirmation to clear all the reservations and unreserve all the licenses.

Note: The **Clear All** option is disabled if any licenses are checked out.

3. Click **Yes**.

Note: If you click **Yes**, all the reservations are cleared, and all the licenses get unreserved. You cannot undo this action.

All the reservations are cleared, and all the licenses are unreserved.

Reserving Licenses for Users

Reserving a license for a specific user guarantees that the user can use the reserved license as long as the user is authorized by the licensed product.

User reservation is the main use case for reserving connection licenses. Reserving licenses for a user is helpful when the same user needs access to the application from different devices at different times, and be guaranteed to have a license available when needed.

For some products, a license will be reserved for a user automatically when the product acquires the license. No manual reservation procedure is necessary in these cases.

Note: The user identifier entered when reserving licenses must match the user identifier known to the relevant computer or domain.

Reserve Licenses for Users

1. In the **Servers Details** page, click the **User Reservation** tab.
2. Click **Add User**.
The **Add User** dialog box appears.
3. In the **User Name** box, type the name of the user for whom you want to reserve the license.
4. In the **Comment** box, type any additional information about the user reservation.
5. From the list of features, select the check boxes for the features you want to reserve for the user.
Some part numbers have multiple features associated with it. If such a part number is selected, then all features associated with the part number are reserved for the device.
If you want only some of the features associated with the part number to be reserved, not all, then:
 - a. Click on the three dots next to the **Part Number** grid, and then click **Select Partial**.
 - b. The grid displays all the individual features associated with the part number. Select the checkboxes of the feature(s) you want to reserve for the device.
6. Click **Add**.
The user and the selected features are displayed in the **User Reservation** tab.
7. Click **Apply** to apply the changes.
The changes are applied to the selected user.

Video Tutorial: Reservations and Checkouts



Exporting and Importing Reservations for Users

You can export the user reservation details to a .csv file. After exporting the .csv file, you can edit the file to update any existing reservations or add new reservations. If any of the listed licenses is not reserved for a user, you can add the user name to whom you want to reserve the license. You can then import the edited file to the License Manager to update the user reservation details.

To export the User Reservation Details

1. In the **Servers Details** page, click the **User Reservation** tab.
2. Click **Export**.

A message appears asking you to save the reservation details.

3. Click **Save**.
4. Browse for the location to save the .csv file.

The .csv is saved with the default filename **Reservations-<UserName>-<Date Time>**.

For example, if you exported the reservation details for the user “User-1” on January 2, 2020, at 15:00, then the filename is **Reservations-User-1-02-01-2020 15_00_00**.

5. Open the .csv file.

The following details are available:

- User name
- Count
- Feature
- Part number
- Version
- Expiry
- Comment
- Action

If you reserve partial features associated with a part number, then the reserved features of that part number and their count appear after the aforementioned details.

To edit the .csv file

1. Browse to the location where the .csv file is available.
2. Open the .csv file.
3. Edit the file as required.

If any of the listed licenses is not reserved for a user, you can add the user name to whom you want to reserve these licenses.

4. Save the .csv file.

To import the User Reservation Details

1. On the **Servers Details** page, click the required server tile.

2. Click the **User Reservations** tab.
3. Click **Import**.
4. Browse to the location where the .csv file is available.
5. Select the .csv file and then click **Open**.
6. Click **Apply**.

The updated reservation details appear in the grid.

Canceling, Deleting, or Clearing User Reservations

You can cancel the reservation changes or delete a user reservation. You can also clear all the user reservations and unreserve all the licenses.

Cancel the License Reservation for Users

To cancel all the user reservation changes made, which are yet to be applied:

1. In the **Servers Details** page, click the **User Reservation** tab.
2. Click **Cancel**.

A message appears asking your confirmation to cancel all the changes.

3. Click **Yes**.

All the changes made in the **User Reservation** tab, which are yet to be applied, are canceled.

To cancel the reservation changes for a newly added user, where the changes are yet to be applied:

1. In the **Servers Details** page, click the **User Reservation** tab.
2. Click the **Cancel** (✖) icon for the user reservation that you want to delete.

A message appears asking your confirmation to cancel the row.

3. Click **Yes**.

The selected user reservation is canceled.

Deleting User Reservations

1. In the **Servers Details** page, click the **User Reservation** tab.
2. In the **Action** column, click the **Delete** (🗑) icon for the user reservation that you want to delete.

The details of the selected row are struck out.

3. Perform either of the following:

- If you want to apply the changes, click **Apply**.

The selected user reservation is deleted.

- If you want to cancel the changes, click the **Cancel**. In the **Confirmation** dialog box, click **Yes** to cancel all the changes.

The changes made to the user reservation(s), which are yet to be applied, are canceled.

Clearing all User Reservations

1. In the **Servers Details** page, click the **User Reservation** tab.
2. Click **Clear All**.

A warning message appears asking your confirmation to clear all the reservations and unreserve all the licenses.

3. Click **Yes**.

Note: If you click **Yes**, all the reservations are cleared, and all the licenses get unreserved. You cannot undo this action.

All the reservations are cleared, and all the licenses are unreserved.

Checking Out Licenses

Checkout is the process in which the licenses get permanently acquired on a node. You can reserve and checkout licenses for a device. After the checkout process, these licenses do not require the License Server.

If you check out a license with an expiration date, the license gets permanently checked out until the license expires.

You can either check out licenses using the License Manager (from the **Device Reservation** tab) or using the Checkout utility. For more information about checking out licenses using License Manager and Checkout utility, see [Checking Out Licenses using License Manager](#) and [Checking Out Licenses using the Checkout Utility](#).

Note:

- Ensure that you use one of these methods to check out licenses and not a combination of both.
 - In a redundant pair scenario, the checkout and check-in operations are successful only if the servers are in a connected state.
 - To be able to checkout licenses, the Server node, Manager node and the relevant Client node should be upgraded to version 3.6 or higher.
-

Checking Out Licenses using License Manager

You can check out licenses for devices based on features.

To check out licenses for devices

1. In the **Servers Details** page, click the **Device Reservation** tab.
2. Select the **Checkout** check boxes for the features you want to check out.
3. In the **Comment** box, type the comment for the checkout.
4. Click **Apply**.

The selected licenses are checked out.

In the **Usage Summary** tab, the selected features are displayed in the **Reservation** and **In Use** columns.

In the **Usage Details** tab, the selected features are displayed as Checked-out in the **Expected Return** column.

5. To check in the checked-out features, clear the check boxes for the required features, and then click **Apply**.

The selected features are checked in, and the details in the **Usage Summary** tab and the **Usage Details** tab are updated accordingly.

Note: If the device is not in the connected state, the check-in operation fails. You can forcefully check in the license by performing the drop device operation. For more information about dropping devices, see [Dropping Devices](#).

Video Tutorial: Reservations and Checkouts



Checking Out Licenses using the Checkout Utility

About Checkout Utility

The Checkout Utility allows you to reserve and check out or unreserve and check in the licenses or a given part number. It also provides a list of checked out part numbers on a node.

When you check out a part number, all the features belonging to the part number are checked out. For example, if the selected part number has four features, then these four features are checked out when you check out the part number.

Checkout Utility Commands

In the Checkout Utility, you can use the command as follows:

```
AELicCheckout.exe [ checkout | checkedoutlist | checkin | checkinall ] [-pn <partnumber1, partnumber2=[unit count],...> | -I <part number file path>]
```

Where:

- [checkout] -> Checks out the listed part number(s).
- [checkedoutlist] -> Lists all checked out part number(s).
- [checkin] -> Checks in given part number(s).
- [checkinall] -> Checks in all checked out part number(s).
- [-pn <partnumber1, partnumber2=[unit count],...>]
List of part number(s) with unit count.
Unit count is the number of units to be checked out/checked in. The default value is 1.
Unit count 'ALL' will check out/check in total count of part number(s).
- [-I <part number file path>] List of part number(s) specified in the text file.
Part number file should contain a list of part number(s) delimited by comma.
Example: WSP-23-N-17,WSPRT-02-N-17=1,InTR60K17.

Following are a few sample commands:

Sample 1 A

```
AELicCheckout.exe checkout -pn WSP-23-N-17,WSPRT-02-N-17=2,WSP-23-N-18=ALL
```

The above command checks out the part numbers as follows:

- Part number WSP-23-N-17 with unit count 1
- Part number WSPRT-02-N-17 with unit count 2
- Part number WSP-23-N-18 with total count

Sample 1 B

```
AELicCheckout.exe checkout -pn -I D:\inputfile.txt
```

The above command checks out all the part numbers specified in the inputfile.txt.

Following is an example of the content from a sample input file:

```
Tst-HistEnt02-17=1,DevStd-04-T-20=1,SupClt-01-N-17=1
```

Sample 2

```
AELicCheckout.exe checkedoutlist
```

The above command lists all checked out part numbers.

Sample 3 A

```
AELicCheckout.exe checkin -pn WSP-23-N-17,WSPRT-02-N-17=2,WSP-23-N-18=ALL
```

The above command checks in the part numbers as follows:

- Part number WSP-23-N-17 with unit count 1
- Part number WSPRT-02-N-17 with unit count 2
- Part number WSP-23-N-18 with total checked out count.

Sample 3 B

```
AELicCheckout.exe checkin -pn -I D:\inputfile.txt
```

The above command checks in all the part numbers specified in the inputfile.txt.

Following is an example of the content from a sample input file:

```
Tst-HistEnt02-17=1,DevStd-04-T-20=1,SupClt-01-N-17=1
```

Sample 4

```
AELicCheckout.exe checkinall
```

The above command checks in all checked out part numbers.

Security Requirements

The Checkout Utility can only be accessed by a user who is an admin or a member of the **AELicMgr** security group on the local computer on which the AELicensingPlatform is installed.

Using the Checkout Utility

1. Open Command Prompt as an Administrator.
2. At the command prompt, type the path where the Checkout Utility is available.
For example, **C:\Program Files (x86)\Common Files\ArchestrA\Licensing Framework\License API2.**
3. Type **AELicCheckout.exe** and then type the following:
 - The path where the utility is available

- The operation you want to perform
- The part number

For example, if the utility is available in the path C:\Program Files (x86)\Common Files\Archestra\Licensing Framework\License API2, and you want to check out the part number INTR60K17, then type the following:

```
C:\Program Files (x86)\Common Files\Archestra\Licensing Framework\License API2
AELicCheckout.exe checkout -pn "INTR60K17"
```

4. Press **Enter**.

The checked-out licenses are displayed on the **Reservations** grid of the License Manager, with details such as Serial Number, Product Name, Component Name, Version, and Count.

Note: The licenses get checked out through the primary server. Therefore, if you are using a redundant pair, the primary server is required to be available during the checkout operation.

Dropping Devices

You can drop a device to release all acquired and reserved licenses associated with it.

Note: In a redundant pair scenario, the drop device operation is successful only if the servers are in a connected state.

To drop devices

1. Click **Manage** on the **Action Bar**.

The **Manage License Server** slide out panel appears.

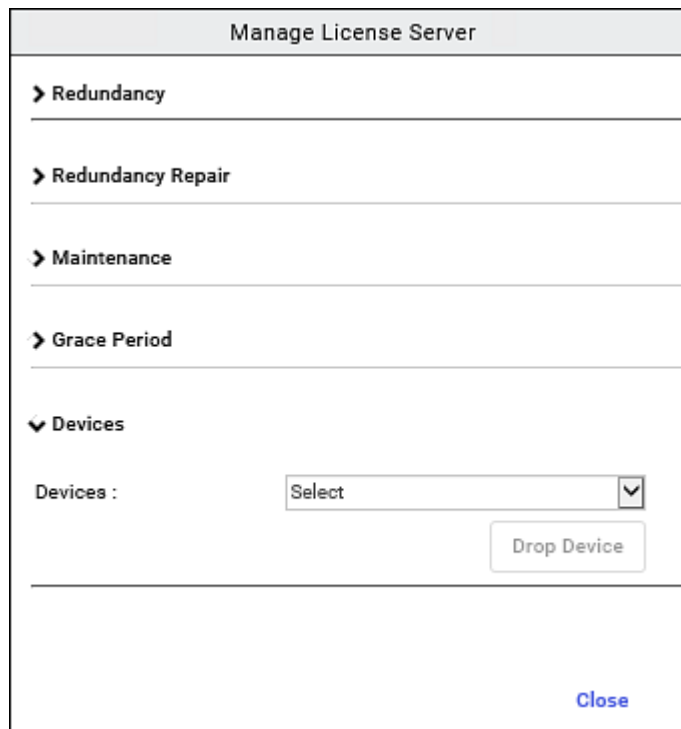

2. Under **Devices**, select the device you want to drop from the **Devices** drop-down list.
3. Click **Drop Device**.
A message appears asking your confirmation to release the licenses.
4. Click **Yes**.
All the acquired and reserved licenses associated with the device are released.

Setting Product Compatibility

The **Legacy Support** option in the **Manage** pane allows you to set product compatibility. By default, this option is checked. This implies that client nodes with earlier versions of Licensing can acquire a license. If the **Legacy Support** option is unchecked, then only client nodes with the 4.0 version of Licensing can acquire a license.

To set product compatibility

1. Click **Manage** on the **Action Bar**.
The **Manage License Server** slide out panel appears.

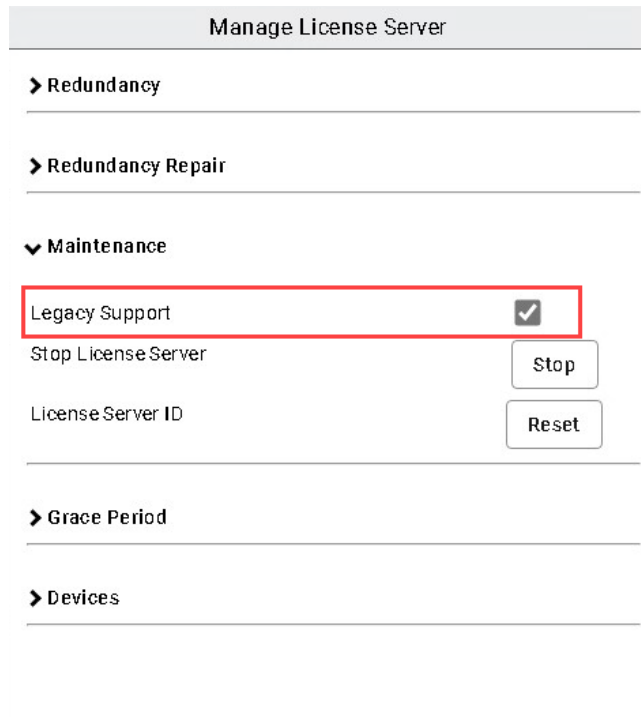

2. Under **Maintenance**, uncheck the Legacy Support checkbox if you want the license to be acquired only by client nodes that use Licensing 4.0.
A confirmation message appears.
3. Click **Yes**.

Monitoring License Usage

After a license is activated, it can be acquired by products.

An activated license typically is acquired from the moment you start up the licensed product and is in-use as long as the product is running. When you exit or shut down the product, depending on the product itself, the license is released and returned to the License Server, where it remains available for future use.

Note: This behavior may vary on a product-by-product basis.

Video Tutorial: Usage Views



About Monitoring License Usage

You can view **Usage Summary** and **Usage Details** information by clicking the respective tabs on the License Manager details page.

The **Usage Summary** grid shows the license usage, as well as other basic information for active licenses.

| Feature | Part Number | License Type | Version | Quantity | Reservation | In Use |
|--|----------------|--------------|-------------|----------|-------------|--------|
| Batch Management Server, Unlimited Units | AdvStd-02-N-17 | Server | 2017 (12.1) | 1 | 1 | 1 |
| Batch Management Server, Unlimited Units | AdvStd-04-N-17 | Server | 2017 (12.1) | 1 | 1 | 1 |
| Batch Management Development Client | AdvStd-02-N-17 | Client | 2017 (12.1) | 1 | 1 | 1 |
| Batch Management Development Client | AdvStd-04-N-17 | Client | 2017 (12.1) | 1 | 0 | 0 |
| Workflow Management - DevStudio Edition | AdvStd-02-N-17 | Server | 2017 (6.0) | 1 | 0 | 0 |
| Workflow Management - DevStudio Edition | AdvStd-04-N-17 | Server | 2017 (6.0) | 1 | 0 | 0 |
| Skelta BPM Client Connection | BPM-12-N-17 | Client | 2017 (5.0) | 50 | 0 | 0 |
| Workflow Management Client Connection | AdvStd-02-N-17 | Client | 2017 (6.0) | 20 | 0 | 0 |
| Workflow Management Client Connection | AdvStd-04-N-17 | Client | 2017 (6.0) | 20 | 0 | 0 |
| Skelta BPM - Forms | BPM-03-N-17 | Server | 2017 (5.0) | 2 | 0 | 0 |
| Workflow Management Forms | AdvStd-04-N-17 | Server | 2017 (6.0) | 1 | 0 | 0 |

77 License(s) found

The **Usage Details** grid shows detail information for acquired licenses.

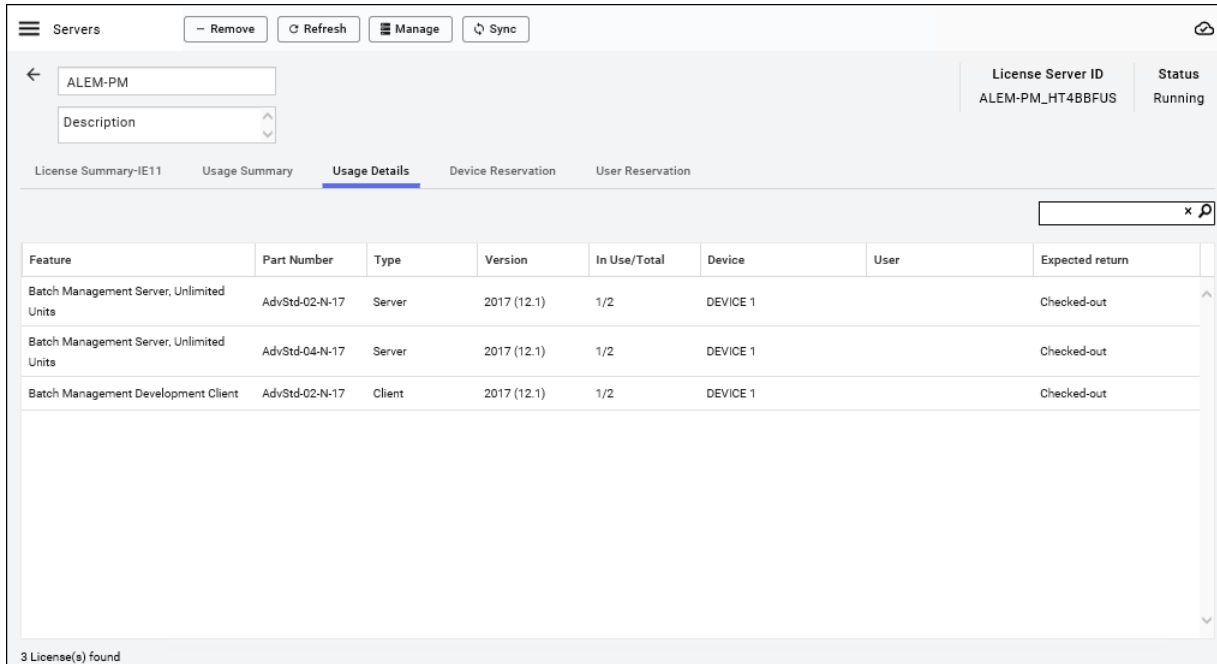

Viewing License Usage Summary Information

To view a summary of license usage

- In the main License Manager window, just above the license grid, click the **Usage Summary** tab. The **Usage Summary** grid is displayed. Click a column heading to sort the list by that column.
 - The **Feature** column displays the feature names of all activated licenses.
 - The **Part Number** column displays the part numbers for the specific feature.
 - The **License Type** column displays the type of license feature.
 - The **Version** column displays the license feature version number.
 - The **Quantity** column displays the total number of licenses available for the specific feature.
 - The **Reservation** column displays the reservations for each license feature.
 - The **In Use** column indicates the license has been acquired by a product.

| Feature | Part Number | License Type | Version | Quantity | Reservation | In Use |
|--|----------------|--------------|-------------|----------|-------------|--------|
| Batch Management Server, Unlimited Units | AdvStd-02-N-17 | Server | 2017 (12.1) | 1 | 1 | 1 |
| Batch Management Server, Unlimited Units | AdvStd-04-N-17 | Server | 2017 (12.1) | 1 | 1 | 1 |
| Batch Management Development Client | AdvStd-02-N-17 | Client | 2017 (12.1) | 1 | 1 | 1 |
| Batch Management Development Client | AdvStd-04-N-17 | Client | 2017 (12.1) | 1 | 0 | 0 |
| Workflow Management - DevStudio Edition | AdvStd-02-N-17 | Server | 2017 (6.0) | 1 | 0 | 0 |
| Workflow Management - DevStudio Edition | AdvStd-04-N-17 | Server | 2017 (6.0) | 1 | 0 | 0 |
| Skelta BPM Client Connection | BPM-12-N-17 | Client | 2017 (5.0) | 50 | 0 | 0 |
| Workflow Management Client Connection | AdvStd-02-N-17 | Client | 2017 (6.0) | 20 | 0 | 0 |
| Workflow Management Client Connection | AdvStd-04-N-17 | Client | 2017 (6.0) | 20 | 0 | 0 |
| Skelta BPM - Forms | BPM-03-N-17 | Server | 2017 (5.0) | 2 | 0 | 0 |
| Workflow Management Forms | AdvStd-04-N-17 | Server | 2017 (6.0) | 1 | 0 | 0 |

77 License(s) found

Note: If you see a ∞ symbol in the Quantity column, it means that an unlimited number of features are available to be acquired for that particular license. The quantity column would display the feature count like this: 2/ ∞.

Viewing License Usage Detail Information

To view license usage details

- In the main License Manager window, just above the license grid, click the **Usage Details** tab. The **Usage Details** grid is displayed. Click a column heading to sort the list by that column.
 - The **Feature** column displays the name of the feature.
 - The **Part Number** column displays the part numbers for the specific feature.
 - The **Type** column displays the type of license feature.
 - The **Version** column displays the license feature version number.
 - The **In Use/Total** column displays the number of licenses in use against the total number of available licenses for that feature.
 - The **Device** column displays the name of the device on which the license is in use.
 - The **User** column displays the name of the user who has acquired the license
 - The **Expected return** column displays the expected date and time the license will be released and returned to the server for re-use.

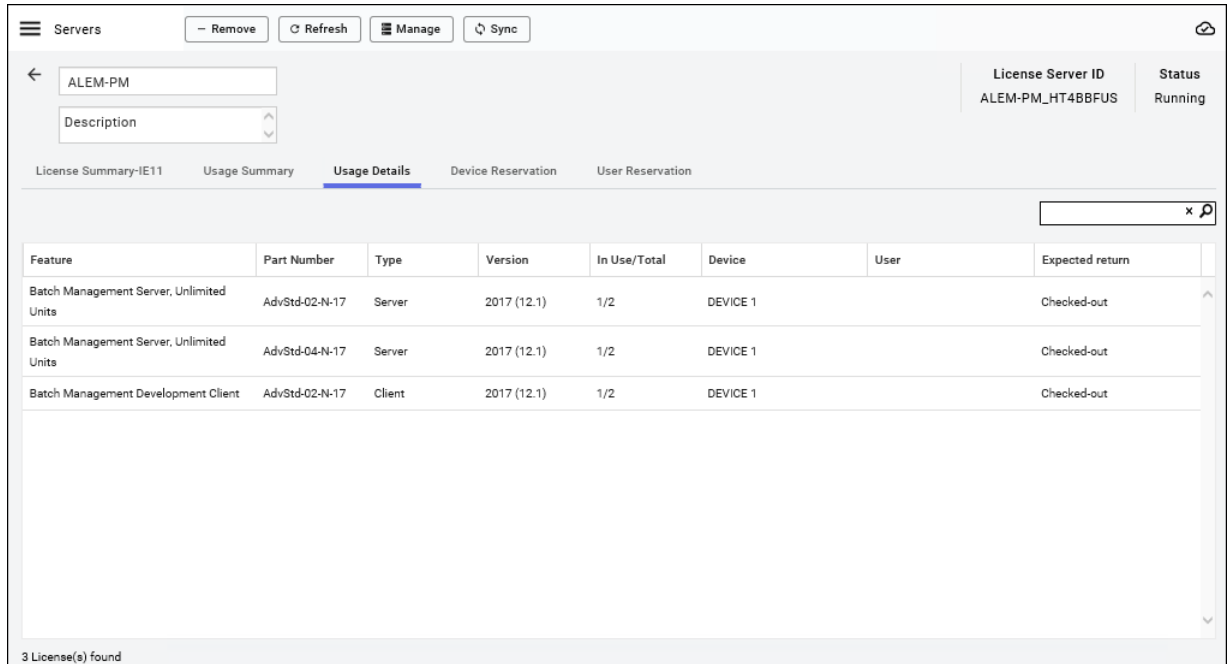

About Changing Default Port Settings

The License Manager components and the License Server rely on several Windows services, each of which requires correct firewall configuration to access the Internet and your network:

- License Server Core Service
- License Server Agent Service

License Manager uses the same ports as the two License Server Windows services, and must also be configured with access to the internet and to your network.

Depending on your particular environment, you may need to change the default port settings.

Caution! Be very careful when changing port settings. Doing so may impact product operation. The topics in this section detail how to go about changing the settings.

The following table lists the various ports.

| Port numbers | Description | Change the port numbers |
|--------------|-------------|-------------------------|
|--------------|-------------|-------------------------|

| | | |
|--------------|---|---|
| <p>55559</p> | <p>The port 55559 is used as a License Server Core Service Port on the secure License Server.</p> <p>Port 55555 was previously used as the Licenses Server Core Service Port. This port is still used for legacy clients that support older versions of the License Server.</p> | <p>On the License Server node:</p> <ul style="list-style-type: none"> • local-configuration.yaml file For more information, see Changing the Default License Server Core Service Port. <p>On the License Manager node:</p> <ul style="list-style-type: none"> • PortConfig.xml file For more information, see Updating Ports on License Manager Nodes. <p>On the product node:</p> <ul style="list-style-type: none"> • ServerConfig.xml file For more information, see Updating Ports on Product Nodes. |
| <p>59200</p> | <p>The port 59200 is used as a License Server Agent Port on the License Server node and the Product License Service port on the product node.</p> <hr/> <p>Note: If you want to change the default port, you have to change the port in the License Server node and the product node.</p> | <p>On the License Server node:</p> <ul style="list-style-type: none"> • LicServer.WindowsService.exe.config file For more information, see Changing the Default License Server Agent Port. <p>On the License Manager node:</p> <ul style="list-style-type: none"> • PortConfig.xml file For more information, see Updating Ports on License Manager Nodes. <p>On the product node:</p> <ul style="list-style-type: none"> • ServerConfig.xml file For more information, see Updating Ports on Product Nodes. • ProductLicenseWindowsService.exe.config file For more information, see Changing Ports for Product License Service. |

| | | |
|-------|--|---|
| 59201 | <p>The License Server Agent port for gRPC communication is 59201.</p> <hr/> <p>Note: Port 59201 is used with version 4.0 or higher of the AVEVA Enterprise Licensing platform.</p> | <p>On the License Server node:</p> <ul style="list-style-type: none"> • appsettings.json file <p>For more information, see Updating Ports on License Manager Nodes.</p> <p>On the License Manager node:</p> <ul style="list-style-type: none"> • PortConfig.xml file <p>For more information, see Updating Ports on License Manager Nodes.</p> <p>On the product node:</p> <ul style="list-style-type: none"> • ServerConfig.xml file <p>For more information, see Updating Ports on Product Nodes.</p> |
| 80 | <p>The port 80 is used as a License Manager port.</p> <p>License Manager is configured to leverage port 80 as a shared port, assuming that the default was taken when the server was configured or set up.</p> | <p>On the License Manager node:</p> <ul style="list-style-type: none"> • PortConfig.xml file <p>For more information, see Updating Ports on License Manager Nodes.</p> |
| 443 | <p>The port 443 is used as a License Manager Secure port.</p> | <p>On the License Manager node:</p> <ul style="list-style-type: none"> • PortConfig.xml file <p>For more information, see Updating Ports on License Manager Nodes.</p> |

Changing the Default License Server Core Service Port

The **License Server Core Service** is one of two Microsoft Windows services used by the License Server. The default port is 55559, but may require configuration if one of the following is true:

- Your firewall blocks port 55559 explicitly or implicitly
- Port 55559 is already in use on your system

Port 55559 is one of a range of ports used as temporary, local "scratch" ports when Internet clients, such as web browsers, email, and browser-based applications such as AVEVA Enterprise License Manager and License Server connect to the service ports of remote Internet servers.

The License Server Core Service port is controlled by the **local-configuration.yaml** file installed as part of License Server. The License Server Core Service must be registered and running on your computer. You can verify this with Windows Task Manager, **Services** tab.

To change the License Server Core Service port

1. On the computer where License Server is installed, use a file editor such as Notepad or any commercially available XML editor to open **local-configuration.yaml** from the installed location:
 - 32-bit operating system path: C:\Program Files\Common Files\Archestra\Licensing Framework\License Server\Server\local-configuration.yaml
 - 64-bit operating system path: C:\Program Files(x86)\Common Files\Archestra\Licensing Framework\License Server\Server\local-configuration.yaml
2. Update the HTTPS listening port with the desired port number.

```
# HTTPS server mode
https-in:
  # Set to true to enable
  enabled: true
  # HTTPS listening port
  port: 55559
  # Path to keystore
  keystore-path: C:\Program Files\Common Files\Archestra\Licensing Framework\License Server\Engine\lib\security\Ja
  # Keystore password. You can obfuscate this with java -jar flexnetls.jar -password your-password-here
  keystore-password:
```

Note: If you are using the legacy port 55555, then you have to change the port number in the # HTTP listening port section which appears in the beginning of the file.

3. Restart the **License Server Core Service**.
4. Open the new port in your firewall.

You might need to consult your company Information Technology department for enterprise firewall configuration.

For how-to information, see [Opening a Port in Your Firewall](#).
5. Open the product **Configurator** and provide the configured port number. For how-to information, see [Configure license server for the product](#), [Configure license server for the product](#).

Changing the Default License Server Agent Port

The **License Server Agent Service** is one of two Microsoft Windows services used by the License Server. Port 59200 is the default License Server Agent port that uses WCF communication. The License Server Agent can also communicate with clients using the gRPC protocol using port 59201. Port 59201 is used with version 4.0 or higher of the AVEVA Enterprise Licensing platform.

The default port is 59200 / 59201, but may require configuration if one of the following is true:

- Your firewall blocks port 59200 / 59201 explicitly or implicitly
- Port 59200 / 59201 is already in use on your system

Port 59200 is one of a range of ports used as temporary, local "scratch" ports when Internet clients, such as web browsers, email, and browser-based applications such as AVEVA Enterprise License Manager and License Server connect to the service ports of remote Internet servers.

The License Server Agent Service default port for WCF communication (59200) is controlled by the **LicServer.WindowsService.exe.config** file installed as part of License Server. The License Server Agent Service must be registered and running on your computer. You can verify this with Windows Task Manager, **Services** tab.

The License Server Agent Service port for gRPC communication (59201) is controlled by the **appsettings.json** file.

To change the License Server Agent Port

1. On the computer where License Server is installed, use Notepad or another text editor to open the **LicServer.WindowsService.exe.config** (for the WCF port) or the **appsettings.json** (for the gRPC port) file from the installed location:
 - Port 59200 (WCF communication):
 - 32-bit operating system path: C:\Program Files\Common Files\ArchestrA\Licensing Framework\License Server\LicServer.WindowsService.exe.config
 - 64-bit operating system path: C:\Program Files(x86)\Common Files\ArchestrA\Licensing Framework\License Server\LicServer.WindowsService.exe.config
 - Port 59201 (gRPC communication):
 - 32-bit operating system path: C:\Program Files\Common Files\ArchestrA\Licensing Framework\License Server\appsettings.json
 - 64-bit operating system path: C:\Program Files(x86)\Common Files\ArchestrA\Licensing Framework\License Server\appsettings.json
2. Change the port number as necessary, then save and close the file. See the following illustrations for the relevant text to edit:

Port 59200:

```

11
12 <!--End point address-->
13 <endpoint address="" binding="netTcpBinding" bindingConfiguration="NetTopBinding_Endpoint"
14 name="NetTopBindingEndpoint" contract="LicServer.IAgentService.ILicenseServerActivity">
15 <identity>
16 <dns value="localhost" />
17 </identity>
18 </endpoint>
19
20 <!--Mex end point address-->
21 <endpoint address="mex" binding="netTcpBinding" bindingConfiguration="NetTopBinding_Endpoint1"
22 name="MexTopBidingEndpoint" contract="IMetadataExchange" />
23
24 <!--base address for the License server activity-->
25 <host>
26 <baseAddresses>
27 <add baseAddress="net.tcp://localhost:59200/LicenseServerActivity" />
28 </baseAddresses>
29 </host>
30
31 </service>
32
33 <!--Service Behaviour-->
34 <service behaviorConfiguration="AgentServiceBehavior"
35 name="LicServer.AgentService.SyncProcessor">
36
37 <!--End point address-->
38 <endpoint address="" binding="netTcpBinding" bindingConfiguration="NetTopBinding_Endpoint"
39 name="NetTopBindingEndpoint" contract="LicServer.IAgentService.ISyncProcessor">
40 <identity>
41 <dns value="localhost" />
42 </identity>
43 </endpoint>
44
45 <!--Mex end point address-->
46 <endpoint address="mex" binding="netTcpBinding" bindingConfiguration="NetTopBinding_Endpoint1"
47 name="MexTopBidingEndpoint" contract="IMetadataExchange" />
48
49 <!--base address for the License server activity-->
50 <host>
51 <baseAddresses>
52 <add baseAddress="net.tcp://localhost:59200/SyncProcessor" />
53 </baseAddresses>
54 </host>
55 </service>

```

Port 59201:

```

},
  "HttpServer": {
    "Endpoints": {
      "Https": {
        "Host": "localhost",
        "Port": 59201,
        "Scheme": "https",
        "StoreName": "My",
        "StoreLocation": "LocalMachine"
      }
    }
  }
}

```

3. Restart the **License Server Agent Service**.

Open the new port in your firewall. For how-to information, see [Opening a Port in Your Firewall](#).

Updating Ports on License Manager Nodes

License Manager represents the client side of the client/server licensing system, and needs to use the same ports for communication as those configured for License Server. License Manager ports are controlled by the **PortConfig.xml** file.

The default ports, detailed in the following steps, are **55559**, **59200 / 59201**, **80**, and **443**.

- Port **55559** and port **59200 / 59201** belong to a wide range of ports used as temporary, local "scratch" ports when Internet clients, such as web browsers, email, and browser-based applications such as AVEVA Enterprise License Manager and License Server connect to the service ports of remote Internet servers.
- License Manager is configured to leverage port **80** as a shared port, assuming that the default was taken when the server was configured or set up.
- Port **443** is a default port number which is used to communicate with the System Management Server. However, if the System Management Server is configured on a different port, then the License Manager can be configured with a new port by updating the port number in the **PortConfig.xml** file

Important: If you configure your License Manager with a port number other than the default port 80, you need to include the port number in the browser URL to access License Manager. Use this URL: `https://<nodename>:<portnumber>/AELicenseManager`.

To update ports on the License Manager node

1. On the computer where License Manager is installed, use a text editor such as Notepad or any commercially available XML editor to open **PortConfig.xml** from the installed location:
 - **C:\ProgramData\AVEVA\Licensing\License Manager\Data\PortConfig.xml**
2. Update the port numbers in the **PortConfig.xml** file, then save and close the file.
 - a. Update <JavaLicenseServerPort> with the same number configured for the License Server. The default port is **55559**.
 - b. Update <LicenseServerAgentPort> with the same number configured for the License Server agent that communicates over the WCF protocol. The default is port **59200**.
 - c. Update <LicenseServerAgentSecureServicePort> with the same number configured for the secure License Server agent that communicates over the gRPC protocol. The default port is **59201**.
 - d. Update <LicenseManagerPort> with your custom port number for the License Manager. The default is port **80**.
 - e. Update <LicenseManagerSecurePort> with the same custom port number configured for the System Management ServerS. The default port is **443**.

Important: If you change the License Manager Secure port number other than the default port 443, then do the following:
Run the command: **netsh http add urlacl https://smtest6-22:444/AELicenseManager/ user=everyone listen=yes**
Go to **Services** and restart the service: **AVEVA Enterprise License Manager Service**
Launch License Manager with this URL: **https://<machinename>:<customportvalue>/AELicenseManager**.

```
<?xml version="1.0" encoding="utf-8" ?>
<PortConfiguration>
  <LicenseServerPort>5555</LicenseServerPort>
  <LicenseServerAgentPort>59200</LicenseServerAgentPort>
  <LicenseServerAgentSecureServicePort>59201</LicenseServerAgentSecureServicePort>
  <LicenseManagerPort>80</LicenseManagerPort>
  <LicenseManagerSecurePort>443</LicenseManagerSecurePort>
  <DRMHostName>localhost</DRMHostName>
  <RefreshInterval>360000</RefreshInterval>
  <JavaLicenseServerPort>55559</JavaLicenseServerPort>
</PortConfiguration>
```

Updating Ports on Product Nodes

Products use the same ports for communication as the ports configured for License Server and License Server Agent. These ports are controlled by the **ServerConfig.xml** file.

Note: The **ServerConfig.xml** file is available only on the product nodes.

To update ports on product nodes

1. On the computer where License Manager is installed, use a text editor such as Notepad or any commercially available XML editor to open **ServiceConfig.xml** from the installed location:
 - C:\ProgramData\AVEVA\Licensing\ServerConfig.xml
2. Update the port numbers in the **ServerConfig.xml** file, then save and close the file.

```
<?xml version="1.0" encoding="UTF-8"?>
- <ServerConfiguration>
  <ServerType>Local license server</ServerType>
  <HostName>GA-SQL-2019</HostName>
  <BackupHostName> </BackupHostName>
  <PortNumber>5555</PortNumber>
  <LicenseServerPort>55559</LicenseServerPort>
  <LicenseServerAgentServicePort>59200</LicenseServerAgentServicePort>
  <LicenseServerAgentSecureServicePort>59201</LicenseServerAgentSecureServicePort>
  <ServerProtocol>https</ServerProtocol>
  <EndPoint>fne/bin/capability</EndPoint>
  <!-- Host Id Type can be Ethernet or string, If it is string Hostid value should be provided -->
  <HostIdType>Ethernet</HostIdType>
  <HostId> </HostId>
  <BackupServerHostId> </BackupServerHostId>
  <PrimaryFailover>>false</PrimaryFailover>
  <PrimaryStatusTimeLog> </PrimaryStatusTimeLog>
  <BackEndInterval>1440000</BackEndInterval>
  <ClientInterval>600000</ClientInterval>
  <ReleaseInterval>60000</ReleaseInterval>
  <LicenseServerType>JsonEndPoint</LicenseServerType>
</ServerConfiguration>
```

Changing Ports for Product License Service

The **Product License Service** is used by the product nodes to communicate with the License Server. The default port is 59200, but may require configuration if one of the following is true:

- Your firewall blocks port 59200 explicitly or implicitly
- Port 59200 is already in use on your system

The Product License Service port is controlled by the **ProductLicenseWindowsService.exe.config** file installed as part of the product. The **Product License Service** must be registered and running on your computer. You can verify this with Windows Task Manager, **Services** tab.

Port 59200 is the default port that uses WCF communication. However, the Product License Service can also communicate with clients using the gRPC protocol. The Product License Server port for gRPC communication is 50051. Port 50051 is used with version 4.0 or higher of the AVEVA Enterprise Licensing platform.

To change the Product License Service Port

1. On the computer where License Server is installed, use Notepad or another text editor to open the **ProductLicenseWindowsService.exe.config** or **appsettings.json** file from the installed location:
 - WCF communication:
 - 32-bit operating system path: C:\Program Files\Common Files\ArchestrA\Licensing Framework\License API2\ProductLicenseWindowsService.exe.config
 - 64-bit operating system path: C:\Program Files(x86)\Common Files\ArchestrA\Licensing Framework\License API2\ProductLicenseWindowsService.exe.config
 - gRPC communication:
 - 32-bit operating system path: C:\Program Files\Common Files\ArchestrA\Licensing Framework\License API2\appsettings.json
 - 64-bit operating system path: C:\Program Files(x86)\Common Files\ArchestrA\Licensing Framework\License API2\appsettings.json
2. Change the port number as necessary, then save and close the file. See the following illustration for the relevant text to edit.
Port 59200:

```

ProductLicenseWindowsService.exe.config
1 <?xml version="1.0" encoding="utf-8"?>
2 <configuration>
3   <appSettings>
4     <add key="ReregisterTime" value="10000"/>
5   </appSettings>
6   <system.serviceModel>
7     <services>
8       <service behaviorConfiguration="ServiceBehavior"
9         name="ProductLicenseService.Services.CheckOutLicenseService">
10        <endpoint address="" binding="netTcpBinding" bindingConfiguration="NetTcpBinding_Endpoint"
11          name="CheckOutLicenseServiceEndpoint" contract="ProductLicenseServiceInterface.ICheckOutLicenseService">
12          <identity>
13            <dns value="localhost" />
14          </identity>
15        </endpoint>
16        <endpoint address="mex" binding="netTcpBinding" bindingConfiguration="NetTcpBinding_Endpoint1"
17          name="MexnetNamedPipeBindingEndpoint" contract="IMetadataExchange" />
18        <host>
19          <baseAddresses>
20            <add baseAddress="net.tcp://localhost:59200/Services/CheckOutService" />
21          </baseAddresses>
22        </host>
23      </service>
24      <service behaviorConfiguration="ServiceBehavior"
25        name="ProductLicenseService.Services.IMCheckOutLicenseService">
26        <endpoint address="" binding="netTcpBinding" bindingConfiguration="NetTcpBinding_Endpoint"
27          name="IMCheckOutLicenseServiceEndpoint" contract="ProductLicenseServiceInterface.IIMCheckOutLicenseService">
28          <identity>
29            <dns value="localhost" />
30          </identity>
31        </endpoint>
32        <endpoint address="mex" binding="netTcpBinding" bindingConfiguration="NetTcpBinding_Endpoint1"
33          name="MexTcpBidingEndpoint" contract="IMetadataExchange" />
34        <host>
35          <baseAddresses>
36            <add baseAddress="net.tcp://localhost:59200/Services/IMCheckOutLicenseService" />
37          </baseAddresses>
38        </host>
39      </service>
40    </services>
41    <behaviors>
42      <serviceBehaviors>
43        <behavior name="ServiceBehavior">

```

Port 50051:

```
{
  "Logging": {
    "LogLevel": {
      "Default": "Trace",
      "Microsoft": "Warning",
      "Microsoft.Hosting.Lifetime": "Information",
      "System": "Information"
    }
  },
  "HttpServer": {
    "Endpoints": {
      "Https": {
        "Host": "localhost",
        "Port": 50051,
        "Scheme": "https",
        "StoreName": "My",
        "StoreLocation": "LocalMachine"
      }
    }
  },
  "AllowedHosts": "*",
  "Kestrel": {
    "EndpointDefaults": {
      "Protocols": "Http2"
    }
  }
}
```

3. Restart the **Product License Service**.
4. Open the new port in your firewall. For how-to information, see [Opening a Port in Your Firewall](#).

Opening a Port in Your Firewall

When you define new ports for the License Server and License Manager, you must ensure that those ports are open in your firewall.

- Consult your company Information Technology department for enterprise firewall configuration.
- For more detailed procedural information, see Microsoft's operating system online documentation.

Chapter 5

Troubleshooting and FAQs

Diagnosing Licensing Issues

Use the information provided in the following sections to identify an issue you might be experiencing and to implement the recommended solution. If the solution does not resolve the issue, or if the information provided does not answer your specific question, contact Technical Support.

Diagnosing Licensing Issues using Log Messages

Use the Log Viewer as a diagnostic tool to gather more information about an issue. You can view logged messages sent to the Logger, to determine whether all processes are functioning properly. Logger is a background process that stores messages in the system log file.

To start the Log Viewer

1. Open the **Operations Control Management Console (OCMC)**. The OCMC appears with the **Log Viewer** listed in the left pane.
2. Double-click **Log Viewer** to expand its groups. The **Local** group is listed beneath the **Default Group**.

Alternatively, if you don't have OCMC installed, you can:

1. Navigate to C:\Program Files (x86)\Common Files\ArchestrA.
2. Right-click **aaLogViewer.exe**, and then click **Run as Administrator**. Alternatively, double-click **aaLogViewer.exe**.
3. The **User Account Control** dialog box appears. Click **Yes**.

The **Log Viewer** window appears

For more information about the Log Viewer, refer to the Log Viewer Help.

The Log Flag Editor lists all the AVEVA components installed on the node you selected. Use the Log Flag Editor to assign a flag value to each category of the selected messages issued by a license manager component. By switching flags on or off, you can control which categories of messages are saved to the Logger.

To Open the Log Flag Editor

1. Expand the **Log Viewer** list to show AVEVA nodes.
2. Select the node from the list that you want to enable with logging flags.
3. On the **Action** menu, click **Log Flags**.

To set log flags for a single component

1. Select the required component from the **Component** List view or select **Global**.
The Log Flags view shows the log flags for the component you selected. If you select **Global**, all the flags are displayed.
2. In the Log Flags view, select the check boxes of the log flags you want to enable.
3. On the **File** menu, click **Apply**. All component messages from the selected categories are logged.

The following table describes different components of License server, License API, and License Manager:

| Product | Components | Log Flag | Type of Information Logged |
|----------------|--|--------------------------------|---|
| License Server | LicServer | AELicServerInfo AELicServer | Logs any error condition related to the initialization and running of the License Server and its dependencies. These log flags also track issues related to grace period entry usually as a result of copying or cloning a License Server running in a virtual machine environment. |
| | LicServer.AgentService | LicServer SamService | Logs information related to the publishing of licensing information to asset management clients and information related to controlling of the License Service from License Manager. |
| LicAPI | LicAPILoader LicAPIConnection LicAPI | AELicensing | Logs exception messages from software due to input or environment. |
| | LicAPILoader LicAPIConnection LicAPI | Info-Licensing | Logs informational messages during execution of Licensing operations. For example: <ul style="list-style-type: none"> • Not configured to License Server • Trusted storage is not available • There are no acquired Licenses available • Licenses released successfully • License reserved successfully |

| | | | |
|--------------|--|--------------|---|
| | LicAPI | AELicAcquire | Logs custom messages during License Acquisition process. |
| | LicAPI | AELicTiming | Logs total time taken for License Acquisition process. |
| LMWeb | LicServAPI LMWeb.Controller LMWeb.Repository LMWeb.DataAccessor | AELicensing | Informational messages from Licensing operations like capability response created, posted during activation, messages about updating pair status, updating grace period status. |

Opening a Log File

1. From the **Action** menu, click **Open Log File**.
2. Browse to locate the log file, and click **Open**.
3. The saved log messages appear in the message window.

For more information on the Log Flag Editor, refer to the Log Flag Editor User Guide.

License Server Issues and Solutions

The following table provides common License Server-related issues and solutions.

| Operation | Problem Description | Solutions |
|------------------|---|--|
| Server - adding | <p>Adding a secondary License Server fails. Possible causes:</p> <ul style="list-style-type: none"> • License Server components are not installed on the specified node. • The license server port is not open. • The license server name is incorrect. • The server is not accessible. | <p>Solution 1:</p> <p>Reconfigure the License Manager web service to use the local admin account. Using the local system account across workgroups does not provide sufficient security.</p> <p>Solution 2:</p> <ol style="list-style-type: none"> 1. Uninstall License Server/License Manager. 2. Clean up license related folders from C:\ProgramFilesx86 and C:\Program Data. 3. Reboot and reinstall License Server/ License Manager. <hr/> <p>Note: You might need to delete certain Registry keys. If the preceding solutions are insufficient, contact Global Customer Support.</p> |

| Operation | Problem Description | Solutions |
|-----------------------------|---|--|
| Server - adding, redundant | When adding a new License Server for setting up Redundancy, an error message informs you that the License Server is already managed by another License Manager. (License Manager versions 3.1 and earlier.) | <p>Remove this License Server from the other License Manager before adding it to this License Manager.</p> <p>Note: If adding a second server for the purpose of setting up redundancy, that server cannot have had an activated license. If a license has ever been activated on the server, the Server ID must be reset.</p> <p>Refer to Tech Note 2907, Licensing - Best Practices.</p> |
| Server - adding, redundant | Difficulty setting up AVEVA Enterprise Licensing redundancy. | <p>See AVEVA Enterprise Licensing Help, Working with License Server Redundancy.</p> <p>Refer to Tech Note 2907, Licensing - Best Practices.</p> |
| Server - communication with | Communication failure between AVEVA products and a License Server results in product shutdown. | <p>Upgrade to System Platform 2017 Update 1 or contact Technical Support to install hotfix L00146946.</p> <p>For more information, refer to Tech Alert TA274, "Communication failure between Wonderware products and a License Server can result in product shutdown".</p> |
| Server - communication with | The license server is not listed in the License Manager. Using the Configurator to configure the server returns firewall errors. | Disable Proxy in your web browser. |
| Server - communication with | Remote node unable to connect to license server on default port 55555 | Intelligence Software (formerly known as Wonderware Intelligence), Alarm Advisor and Recipe Manager Plus were the first products to use AVEVA Enterprise Licensing. Your product installation might be using version 1.0 in which the License Server ID does not contain the License Server computer name as part of the ID. |

| Operation | Problem Description | Solutions |
|--------------------|--|--|
| Server - redundant | When AVEVA Enterprise Licensing is installed, it sets the License Manager Web Service to Local System Account. This breaks the Redundant License Servers in a Workgroup. | Run the AE Workgroup Licensing Utility (AELicWorkgroup.exe) as an Administrator. |

License Activation Issues and Solutions

The following table provides common License Activation-related issues and solutions.

| Operation | Problem Description | Solutions |
|------------|--|---|
| Activation | Unable to communicate with Activation Server during online activation. | <p>Check that the following conditions are met:</p> <ol style="list-style-type: none"> 1. Able to do offline activation from same computer. 2. Network is available on the computer running License Manager. 3. Make sure the following website is not blocked: https://Aveva.compliance.flexnetoperations.com/deviceservices 4. Local or enterprise firewall is correctly configured: The following ports need to be opened : <ul style="list-style-type: none"> • Web Manager: 80 • Core Service: 55555 • Agent: 59200 • License Manager to Activation server: 443 |
| Activation | Successfully activated a license, then deleted, or formatted, or renamed the License Server prior to deactivating the license. The license can no longer be activated. | See Renaming a License Server . |

| Operation | Problem Description | Solutions |
|-------------------------------|---|---|
| Activation | Licenses disappeared from License Manager even though they were successfully activated. | Contact Technical Support to release the licenses. Reset the License Server ID in License Manager. Activate licenses. |
| Activation | How do I activate licenses? | See the section Activating and Acquiring Licenses . Also, refer to Tech Note TN 1395 - Licensing - Activate License Using ONLINE Activation . Also, refer to Tech Note TN 1396 - Licensing - Activate License Using OFFLINE Activation . |
| Activation | Not able to activate license after it was released by Technical Support. | For License Manager version 3.6, the option to select and activate a license by holding down the Control key and clicking the left mouse button has been removed. For License Manager versions 3.2 to 3.5.1, hold down the Control key and click the left mouse button to select and activate a license that the License Manager thinks is already activated. For versions 3.1 and earlier, contact Technical Support to modify the DB file. After modifying the DB file, you can browse to the XML file from License Manager and activate the license. |
| Activation | Error "LMWeb.Repository The FNE Server encountered an error". | Deactivate pending licenses and reactivate using offline mode. |
| Activation | Failed to activate licenses. | Use Windows Task Manager to start the License Manager Web Service, License Server Agent Service, and License Server Core Service. Make sure License Server is running in License Manager. |
| Activation - entitlement file | How many entitlement IDs can a license file have? | Each XML file has one entitlement ID. One entitlement ID can have many activations. |
| Activation - offline | Not able to sync file when using Offline Activation. | Contact Technical Support to obsolete the License Server. Reset the License Server ID using License Manager. Activate the license again. |

Acquiring Licenses Issues and Solutions

The following table provides common issues and solutions related to acquiring licenses.

| Operation | Problem Description | Solutions |
|----------------------------|---|---|
| Acquire license - lag time | The License Manager takes a long time to acquire license even with reservation. | <p>This issue can occur if the computer on which License Manager is installed is not connected to the internet, which blocks certificate validation necessary to enhance security and reliability.</p> <p>Workaround 1 (preferred):</p> <p>This method changes the default timeout for the certificate check.</p> <ol style="list-style-type: none"> 1. Open the Local Security Policy settings (enter "Local Security Policy" in the Start menu search bar). 2. Select Public Key Policies. 3. Under Object Type, right-click on Certificate Path Validation Settings and select Properties. 4. In the Properties dialog, select the Network Retrieval tab. 5. Select Define these policy settings check box. 6. Set the both the settings under Default retrieval timeout settings to 1 second, or to the value you prefer. Typically, both URL retrieval and path validation cumulative retrieval require only milliseconds to complete. 7. Click Apply and then OK. <p>Workaround 2:</p> <p>This method disables checks for revoked certificates.</p> <ol style="list-style-type: none"> 1. From the Control Panel or Internet Explorer, open Internet Options. 2. Select the Advanced tab and scroll down to Security. 3. Uncheck the, Check for publisher's certificate revocation check box. |

| Operation | Problem Description | Solutions |
|--------------------------------------|--|---|
| | | <p>4. Click Apply and then OK.</p> <p>Workaround 3:</p> <p>This method installs the certificates that the operating system is attempting to validate onto the local machine.</p> <p>Once installed locally, the operating system will no longer need to access the network to retrieve them.</p> <ol style="list-style-type: none"> 1. Locate any DLL or EXE file from AVEVA Enterprise Software. 2. Right-click on the file and select Properties. 3. Select the Digital Signature tab. 4. Select the AVEVA Enterprise certificate from the list and click Details. 5. Select View Certificate. 6. On the dialog that appears, select Install Certificate and follow the prompts to install the certificate on the local machine. 7. Locate the file Flxcore.dll and repeat steps 2 through 6 for it. <p>By default, this file is located in:</p> <p>C:\Program Files (x86)\Common Files\ArchestrA\Licensing Framework\License API2</p> <p>Reference: System Platform 2017 Update 1 ReadMe file, Known Issues #933752.</p> |
| Acquire license - changed or renamed | After renaming a License Server, not able to acquire product licenses. | See Renaming a License Server . |

| Operation | Problem Description | Solutions |
|---------------------------|---|---|
| Acquire - release license | AVEVA InTouch HMI (formerly Wonderware) run-time license is activated on a node and the device becomes unusable. The license was not released by that device. How do I recover the InTouch run-time node? | <p>Contact Technical Support and get the 30-day demo license.</p> <ul style="list-style-type: none"> • Install License Server and License Manager on the new InTouch run-time node and activate the 30-day demo license. • Point the new InTouch run-time node Configurator to use the License Server which has the demo license. |
| Acquire - release license | How do I force a device to release the license? | Use the Configurator to temporarily point the client machine to a different License Server. This will release all licenses in use by that machine. Then point the Configurator back to original License Server. |
| Acquire - release license | How do I correctly release a license? | Close all the application. For example, close WindowMaker, WindowViewer, or the IDE using an orderly shutdown procedure. |

License Reservations Issues and Solutions

The following table provides common issues and solutions related to reserving licenses.

| Operation | Problem Description | Solutions |
|--------------|---------------------------------|--|
| Reservations | When should I use Reservations? | <p>We recommend license reservation when there are different licenses for a single product.</p> <p>Example - reservations unnecessary: On a license server with one Historian license (or sub license) and one InTouch license, there is no need to reserve because only Historian can use the Historian license and only InTouch can use the InTouch license.</p> <p>Example - reservations recommended: if you have an InTouch read only, InTouch read/write and InTouch runtime on the same server, then you need to reserve each to the node that should use them.</p> |

| Operation | Problem Description | Solutions |
|--------------|---|---|
| Reservations | How do I make sure that an Application Server run-time license is taken by a device instead of the DEV license? | Reserve the run-time license to the Application Server run-time node. If this does not resolve the issue, deactivate the DEV license when not in use. This will force the run-time node to acquire the run-time license or reserve the dev license to a non-existent node so that it cannot be acquired. |

Grace Period Issues and Solutions

The following table provides common issues and solutions related to the license grace period.

| Operation | Problem Description | Solutions |
|--------------|---|--|
| Grace period | Server entered Grace period. Need Grace Period EXIT code. | Contact Technical Support for the Grace Period Exit code. |
| Grace period | A License Server is in a grace period. Why? | The following operations will cause a grace period detection: <ul style="list-style-type: none"> • Move – Moving a VM from one environment to another typically invalidates the original. • Clone or copy a License Server. • VHD export – Exporting a Virtual Hard Drive (VHD) from one system to another, then using it to set up a new VM. |

Miscellaneous License Management Issues and Solutions

The following table provides information about miscellaneous license issues and solutions.

| Operation | Problem Description | Solutions |
|--------------------------|---|---|
| Logging | Where are the license log files located? | Log files are typically located at: C:\ProgramData\AVEVA\Licensing\License Server |
| Logging - OCMC log flags | How do I use the OCMC log flags related to licensing? | Turn on following log flags under the Global component. This will ensure that all product licensing component flags are on. Available Log Flags: |

| Operation | Problem Description | Solutions |
|--|---|---|
| | | <ul style="list-style-type: none"> • AELicensing • AELicAcquire • AELicTiming • Info-Licensing • Licensing • LicensingDetailed • LicensingConnection • LicensingBackend |
| <p>OCMC Error - license activation</p> | <p>Error: LMWeb.repository - The remote server returned an error: (502) Bad Gateway. LicenseServerName</p> <p>This issue occurs when the License Manager is unable to talk to the License Server, and hence is unable to activate licenses.</p> | <p>Disable Proxy settings in Internet Options.</p> |
| <p>License expiration</p> | <p>Why does my permanent license have an expiration date?</p> | <p>When a newer version of same license is ordered, the older license will have an expiration date. This is designed to give you six months to upgrade to the new version.</p> <p>You can identify this by viewing the license Details page in License Manager. Sort on the serial number column. You will see two similar serial number with different extension numbers.</p> <p>For example: T17082203-0 T17082203-1</p> <p>In the example, T17082203-0 will have an expiration date 6 months from the date T17082203-1 was created. T17082203-1 will be a permanent license.</p> |

| Operation | Problem Description | Solutions |
|-------------------------------|---|---|
| Permissions - License Manager | Who has permission to modify License Manager? | Any user who is a member of the AELicMgr or Admin group on both License Server and License Manager nodes has the necessary permissions to modify License Manager. |

AVEVA Enterprise Licensing FAQs

What is Borrowed Time?

If a node does not or cannot communicate with the Licenses Server to renew the license, then it will expire after certain time. This time duration is called borrowed time.

There are two types of licenses:

- **Backend type license:** This license is acquired by our server products and has infinite borrow time. This ensures that a license is never lost when a License Server is down for any length of time. The infinite borrow time is applicable if the license is Permanent. If the license has an expiry date, then the borrow time is the license expiry date.
- **Client type license:** This licenses is acquired by our client products and has borrowed time of 20 minutes. This means that if the node does not or cannot communicate with the license server to renew the license, then it will expire in 20 minutes. It will become unusable on the node and the License Server will automatically release it, allowing to be acquired by another node.

Give examples for server products

Window Maker, InTouch Run Time Standalone Window Viewer, InTouch Web Server, Application Server, Historian Server, AVEVA Plant SCADA

Give examples for client products

SupvClient OMI, Historian Client, InSight

How does the License System handle network outages?

When a license is acquired, a 'borrowed time' counter starts counting down. This 'borrowed time' is periodically reset by product refreshing their licenses on a periodic bases with the License Server.

For most company SCADA networks, the licensed nodes will be in permanent contact with the License Server over the SCADA network. However, sometimes the network may be down or disconnected for some time.

When a disconnect occurs, the product software that acquired the license continue to run. But, after the borrowed time is exceeded if the product software shuts down, it cannot be restarted. Once the borrowed time is exceeded the acquired license is automatically released by the License Server making it available for use.

Glossary

Acquire (a license)

An installed product, when running, acquires its activated license from the License Server and releases it when no longer needed.

Activate (a license)

To retrieve a valid license from the Activation Server. The Activation Server takes an Activation ID and provides an activated license in return.

Activation ID

An Alphanumeric code that is provided to the Activation Server in order to activate the license.

Activation Mode

The setting which determines which workflow is followed in order to activate licenses. The Activation mode is either Online or Offline.

Activation Server

An internet-based server that Interacts with the License Manager to activate and deactivate licenses on the License Server. The Activation Server processes requests received by the License Manager and responds with the activation information for the corresponding license server. You do not need to install or maintain the Activation Server.

Entitlement File

A file containing information about specific product licenses, used to transport and activate purchased licenses.

Entitlement ID

A unique identifier that groups all licenses from a single order together.

Grace Period

The grace period is the time allocated (15 days) before a license server will stop serving license when the license server is copied or cloned.

The grace period allows you to continue performing normal licensing functions on the virtual image of the cloned, copied or restore image of a License Server without interruption. The grace period lasts fifteen days. You have the duration of the grace period to update the licenses on the cloned or copied image.

License Manager

The License Manager is a web based application that allows you to manage and maintain licenses on each License Server at run time. It is a standalone utility that can be installed on the License Server computer or any other computer. The License Manager serves as a bridge between disconnected License Server and the Activation Server and can be remotely accessed by any web browser.

License Manager Browser

The License Manager is a web based user interface that can be remotely accessed by any web browser.

License Server

Contains the licenses for your system and stores license usage data that can be accessed by the License Manager. Software application licenses are served by the License Server and can serve on any type of client (Windows, browser, tablets or mobile).

Port

Network communication channel by which different licensing components communicate with one another.

Request File

A file (*.sync) which contains activation information that is generated through the License Manager, in order to acquire a license from the Activation Server.

Response File

A file (*.recv) that is generated by the Activation Server containing license rights for activation through the License Manager.

Serial Number

A unique number identifying a specific license.